



WAVELINE

Roughness and Contour Metrology



Metrology from Jenoptik for your quality control

We deliver solutions that help you optimize your manufacturing process regarding qualitative and economic objectives.

We, the Industrial Metrology Division of the Jenoptik Group, are one of the leading international specialists in high-precision, tactile and non-tactile production metrology.

Our services range from complete solutions for different measuring tasks such as the inspection of surface and form as well as determining dimensions, throughout every phase of the production process including final inspection or in the metrology lab.

Our decades of experience in tactile, optical and pneumatic measurement combined with our global sales and service support network brings us close to you, our customers, enabling us to provide optimal support as a reliable partner.

Our team is looking forward to your inquiry!

Jenoptik – Sharing Excellence

Surface roughness measurement on a wide range of surfaces

Ground surfaces

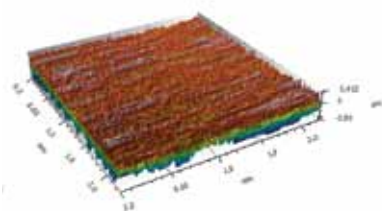

Turned surfaces

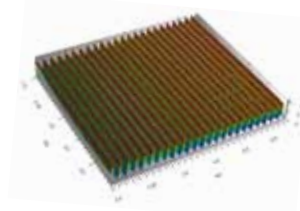

Honed surfaces

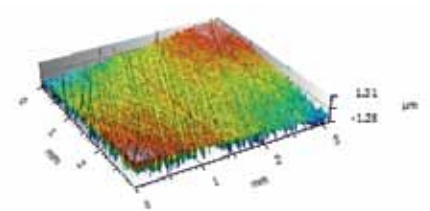

Lasered surfaces

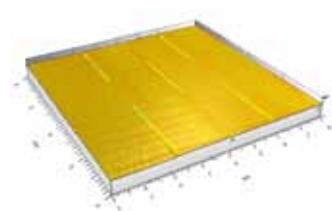

Textured surfaces

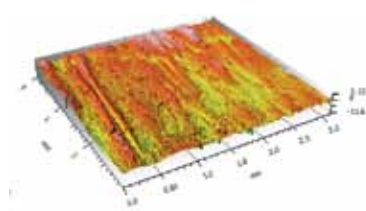

State-of-the-art roughness and contour measurement

WAVELINE measuring systems offer you extensive evaluation possibilities for surface measurement – also possible in combination, depending on the system.

Tactile roughness measurement

- Roughness parameters
- Core roughness parameters
- Profile parameters
- Waviness parameters
- Motif parameters
- JIS parameters
- Topography evaluation
- Dominant waviness
- Twist parameters

Tactile contour measurement

- Angle
- Radius
- Distance
- Parallelism
- Crowning
- Gothic arcs
- Edge geometries
- Line profile
- Threads
- Diameter

Optical surface inspection

- Crosshatch angles
- Area of blowholes
- Radius
- Laser honing structures

Wide range of evaluation possibilities in contour measurement

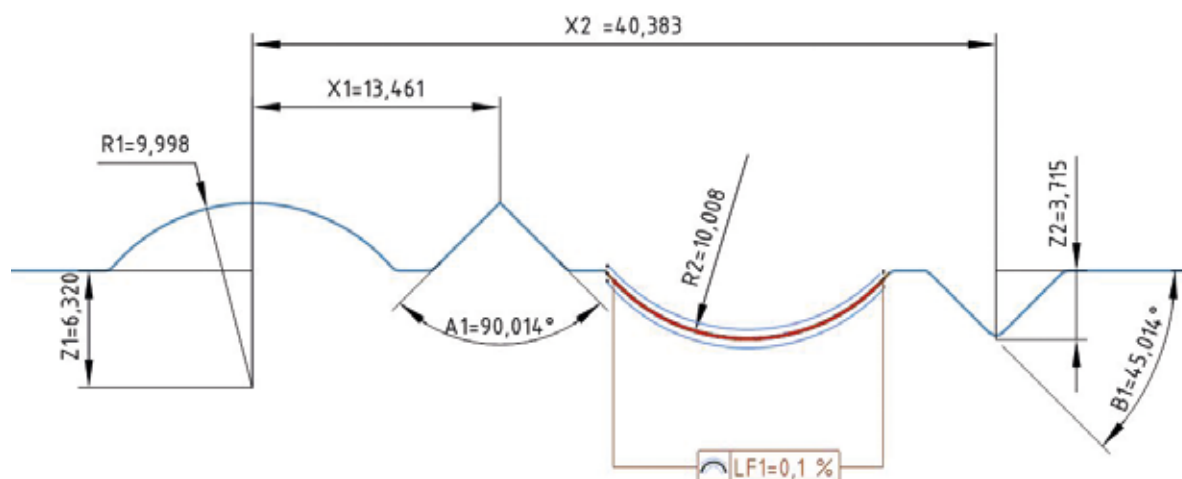



Roughness measurement



Contour measurement

Get better measurements

... with versatility

Whether mobile or stationary, manual or automated, for simple or complex measuring tasks – we supply you with measuring systems that are tailored to your needs.

... in day-to-day operations

Our robust and high-precision solutions provide absolutely precise results in environments close to production. Our systems are easy to operate thanks to an intuitive software interface.

... with flexibility

The WAVELINE systems can be optimally configured to suit a wide range of requirements as needed, with exchangeable probe arms and a comprehensive range of accessories. As a result, these systems are also suitable for different measuring tasks on flexible production lines

... with professional metrology

WAVELINE solutions are the direct result of decades of experience and extensive expertise. They stand out from other products on the market thanks to measurements performed in accordance with international standards, simple operation, and professional evaluation of the measured values.

... with modern technology

Mobile WAVELINE solutions feature wireless *Bluetooth*® technology allowing an almost limitless range of applications. In contour measurement, digital probing systems ensure reliable measurement results without analog limitations.

... with innovative probing systems

Thanks to intelligent probing systems, the correct measuring conditions are automatically set for contour measurements. It is also possible to measure with dual tip probe arms for top/bottom measurements.



Combined roughness and contour measurement



Surface inspection

Tailored to your needs

You have the choice. Our product range consists of mobile surface measuring instruments, stationary measuring systems for manual and automated roughness, contour, topography or twist measurement, combined systems for roughness and contour measurements, as well as measuring instruments for cylinder bores. We also offer measuring stations tailored to meeting your specific measuring requirements.

Systems	Short description	Page
W5, W10 and W20	Mobile roughness measuring instruments	6 – 11
EVOVIS mobile	Control and evaluation software for mobile roughness measuring systems	12 – 13
T8000 and C8000	Stationary roughness and/or contour measurement with separate probing systems	16 – 23
surfscan and nanoscan	Combined roughness and contour measurement with one probing system	24 – 27
EVOVIS	Control and evaluation software for stationary surface measuring systems	28 – 33
POU, wavenslide, wavemove	Individual solutions for production related roughness and contour measurement	44 – 47
toposcan	Surface inspection in cylinder bores	48 – 49
TOPOWIN	Control and evaluation software for surface inspection	50 – 51

Small but powerful – portable, reliable roughness measurement



HOMMEL-ETAMIC W5 with optional printer HOMMEL-ETAMIC P5

Highlights HOMMEL-ETAMIC W5

- Portable and battery-supplied
- Compact and light in design
- Easy, intuitive handling with click wheel and graphical user interface
- Features *Bluetooth*® technology for wireless data transfer and printing
- USB port with Windows-compatible data format and battery charging function
- No calibration necessary
- Battery capacity for up to 800 measurements
- Easily exchangeable probes
- Storage capacity for 5 measuring programs with measuring conditions
- Optional printer P5 for documentation of the measurement results on the spot



Mobile measurement

- Universal roughness measuring instrument for use on the production line, on machine tools or in incoming goods inspection
- Ideal for measurements on big workpieces
- Measurement in all possible measuring positions, including on perpendicular surfaces or overhead



Precise workpiece support, even on small shafts

- Secure positioning and stable workpiece support on precisely ground support shafts on the underside of the measuring device
- Vee-block rest for small shafts with a diameter of 10 mm and above for reliable centering on the correct measuring position; can also be used as probe protection for bores with a diameter of 12 mm and above



Exchangeable probes

- Probes for a range of different measuring tasks
- Probe cover to protect probe from damaging
- Measurement position lighting to view the exact measurement position



Tolerance evaluation

- Colored display of measurement results depending on the tolerance evaluation
- Assessment of measurement results at a glance



Log created directly on site: optional P5 printer

- Compact thermal printer with *Bluetooth*® technology
- Long battery life for mobile measurement documentation
- Paper easy to insert thanks to the Easy Paper Loading function
- Measuring conditions, parameters, tolerance evaluation, roughness profile and Abbott curve can be printed off individually or in combination depending on the measurement program

Model	Probe	Para- meters	Printer	Transverse probing	Profile/ma- terial ratio	Tolerance	Statistics	Measuring programs	Roughness standard
W5	with skid	23	optional	no	no	yes	no	5	optional

Flexible, precise roughness measurement without boundaries



HOMMEL-ETAMIC W10

Highlights HOMMEL-ETAMIC W10

- Mobile and battery-supplied, with cable-free traverse unit
- Usable as stationary instrument
- Modern, intuitive operation via color touchscreen
- Wireless data transfer via *Bluetooth*[®] interface
- Measurement of all common roughness parameters according to international standards
- Integrated printer for documentation of the measurement results on the spot
- Easy changing of the skid probes
- Immediate verification of the W10 via the integrated roughness standard
- Integrated barrel jack for traverse unit
- Storage capacity for 7 measuring programs



Integrated, exchangeable roughness standard

- Safely stored in the basic unit
- Immediate verification of the measuring instrument on site
- Stable measurement configuration
- Measuring program specifically for verification of the measuring instrument with predefined nominal values



Transverse probing

- 90° tilting of the probe for measurements in grooves and incisions or between collars
- Probing of the surface transversely to the traverse direction without complex conversion



Integrated rest and barrel jack

- Secure storage of the traverse unit
- Protection of the probe
- Continuous operational readiness of the traverse unit thanks to the automatic battery charging function



Measurement in all positions

- Measurement of small workpieces in overhead position
- Contact to the workpiece is made by precisely polished shafts on the bottom side of the traverse unit
- 3-point support on the back side of the traverse unit for secure positioning when measuring perpendicular surfaces



Integrated height adjustment

- Extendable tripod legs for adjusting the traverse unit to the height of small workpieces
- Easily adaptable to the desired measuring position

Model	Probe	Para- meters	Printer	Transverse probing	Profile/ma- terial ratio	Tolerance	Statistics	Measuring programs	Roughness standard
W10	with skid	40	integrated	yes	yes	yes	yes	7	integrated

Mobile roughness, waviness and profile measurement in production

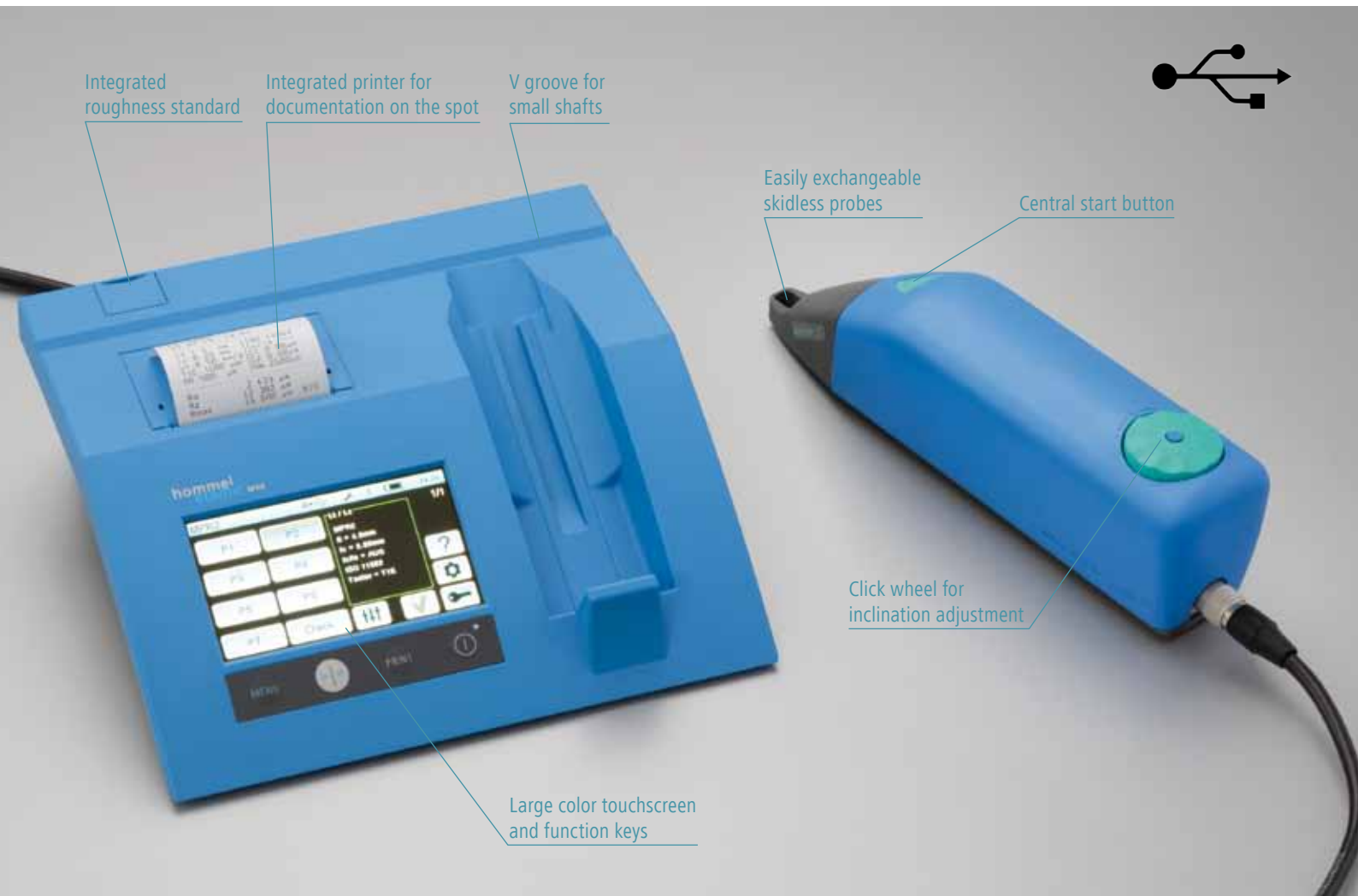

HOMMEL-ETAMIC W20

Highlights HOMMEL-ETAMIC W20

- Modern, intuitive operation via color touchscreen
- Skidless probing system for measurement of all common roughness, waviness and profile parameters according to international standards
- Compact and easy to operate
- Integrated printer for immediate documentation
- Immediate verification of the measuring instrument thanks to the integrated roughness standard
- Easily exchangeable probes for skidless measurements
- 7 measuring programs plus 1 specifically for verification of the device
- Automatic probe positioning to avoid unnecessary adjustments



Traverse unit for skidless measurement

- Integrated start button enables one-handed user control
- High-precision linear guide
- Variable measurement speed
- Software assisted alignment of the reference plane
- Measurement in all positions (also overhead)
- For all our skidless probes



Motorized lowering of the probe

- Automatic positioning of the stylus tip on the workpiece surface and setting of the preselected measuring range
- Automatic lifting of the stylus tip at the end of the measurement to avoid accidental damage during mobile use



Mobile reference plane measurements

- High-precision roughness, waviness and profile measurement in mobile operation
- Performs reference plane measurements and determines the unfiltered P as well as W parameters
- Suitable for measurement of sealing surfaces



Context sensitive operation via touchscreen

- Function keys for the 4 basic functions
- Extensive possibilities for tolerance evaluation
- Fast and comfortable input of additional data via touchscreen
- Clear display of the measurement results
- Results display: parameters, profile view, interactive Abbott curve, extensive statistics functions



Integrated thermal printer

- For documentation of the measurement results on the spot
- Easy-Paper-Loading function
- Printing of measurement results with tolerance evaluation, profiles, Abbott curve, additional information, statistics

Model	Probe	Parameters	Printer	Transverse probing	Profile/material ratio	Tolerance	Statistics	Measuring programs	Roughness standard
W20	skidless	68	integrated	no	yes	yes	yes	7	integrated

EVOVIS mobile: professional evaluation and simple operation of mobile measuring instruments

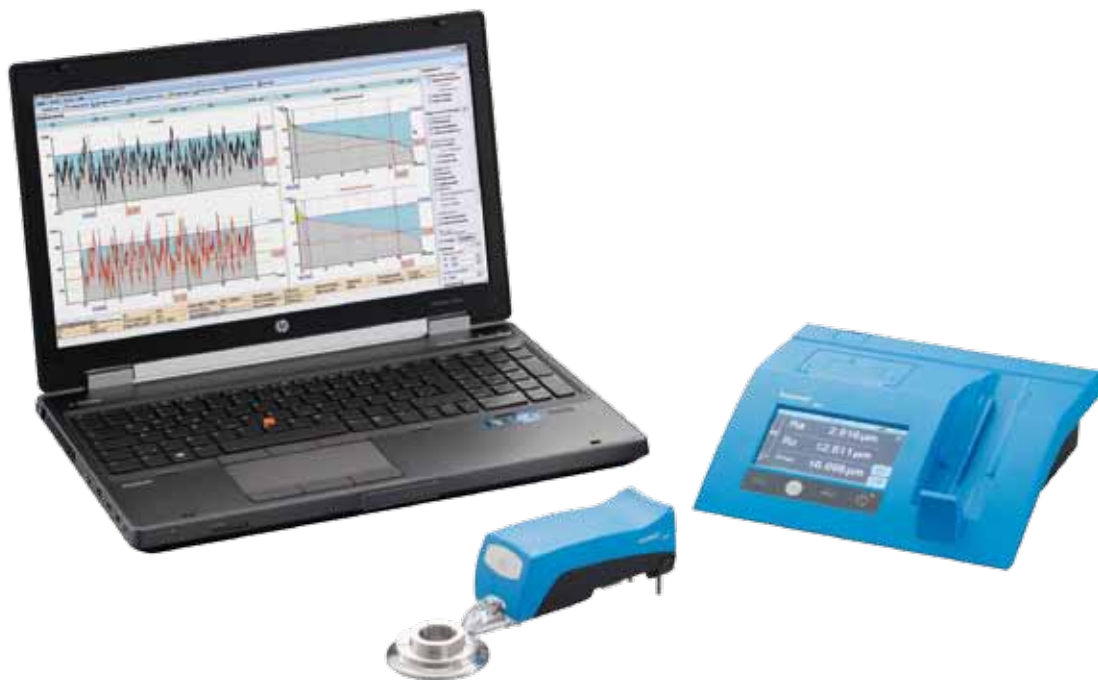

The optional EVOVIS mobile software is specifically designed for operation with mobile measuring instruments. In online mode, the mobile measuring instrument is directly controlled by the software and turns into a stationary measuring station. In offline mode, the locally measured parameters and profile data saved in the measuring instrument are transferred and evaluated on the PC.

Highlights HOMMEL-ETAMIC EVOVIS mobile

- Clear, user-friendly operating structure
- Remote operation of W5, W10 and W20
- Individual test plan creation
- Integrated help with the parameters
- Wizard for selecting the measuring conditions
- Import and subsequent processing of profiles and parameters
- Open design of the print log
- Electronic archiving of reports with PDF printout
- All common roughness and waviness parameters in accordance with ISO 4287 and other ISO and national standards (ASME, DIN, JIS, Motif, etc.)
- Continuous further development of the software in line with new standards/changes in standards
- Optional: qs-STAT® data export interface (description page 31)
- Optional: evaluation of dominant waviness according to VDA 2007 (description page 33)

Customer Jenoptik	Workpiece W32-AC33	
Order A-42BE	Drawing number Z-12344	
Operator Schmidt	Serial number S122	
Comment		

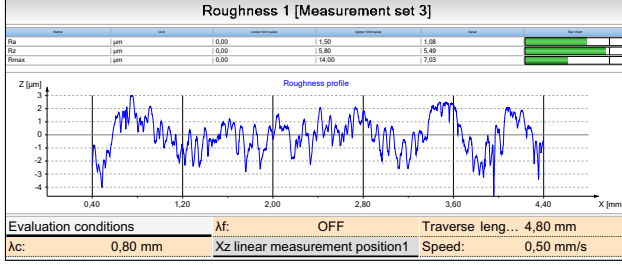
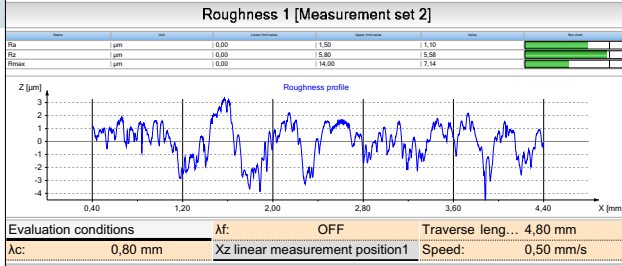
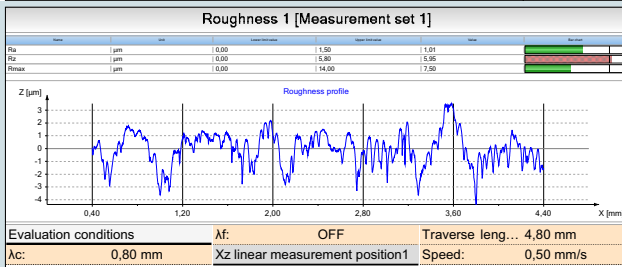

Multiprint log

Free design of print forms

- Log editor for free positioning and processing of the contents from the test plan
- Customization of log templates
- Part data can be provided for the measurement and displayed in the log
- For displaying on screen, for storing as a PDF file and for printing out
- Multiprint log for documentation of several measurements on one page

Defined test plan types

- Online measurement with remote operation and control of the measuring instrument
- Importing of raw profiles stored on the mobile measuring instrument for further evaluation and logging
- Importing and display of the measurement results (parameters) stored on the mobile measuring instrument for logging

Evaluation display

- Numerous options for adjusting the display
- Parameters, result values, tolerances, tolerance violations as a value or bar chart

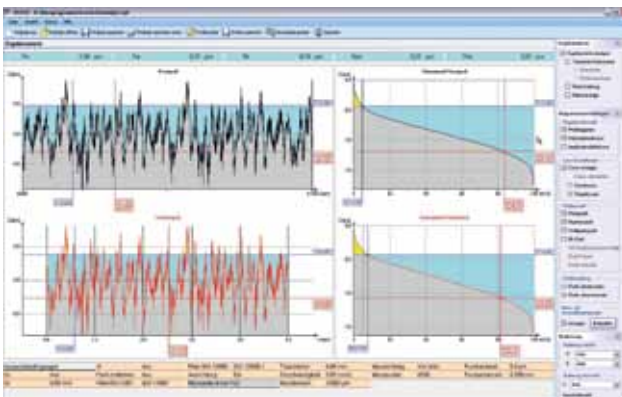

Interactive profile analysis



Measurement and evaluation in online mode

Height stands and accessories

Height stand HS300

Turns the mobile measuring instrument into a stationary measuring configuration. 300 mm height measuring stand with $\pm 180^\circ$ tilting device for precise positioning of the roughness probe on the workpiece surface.

HS300	Art.no. 1004 7611
Adapter W5, W10	Art.no. 1004 9843
Adapter W20	Art.no. 1005 1747
Tilting device for W5, W10	Art.no. 1005 1140



Measuring station

Granite plate with T-groove 400 x 280 mm; height measuring range 300 mm with tilting device $\pm 180^\circ$.
Art.no. 999 011



More accessories such as probe extensions, measuring tables and vee-blocks on pages 40 and 42.

Printer paper

Set of 10 rolls of thermal paper for P5, W10 and W20. Paper width 57 mm, paper length approx. 11 m.
Art.no. 256 016



Probe stop for W5 and W10

Adjustable pendulum stroke limitation of the roughness probe.
Art.no. 1006 8896



Roller adapter for W5 and W10

For simple and reliable roughness measurement directly on roller surfaces. Adjustable for roller diameters 100-180 mm and 180-500 mm.
Art.no. 1005 5622



Magnetic holder for W5 and W10

Enables magnetic fixing of the measuring device/traverse unit on the workpiece surface.
Art.no. 1006 8578



Long-term stable skid probes

All skidded probes have a robust housing and a reliable connector. They are calibrated straight from the factory and provide long term stability thanks to a dual pool system in the inductive converter.

T1E one skid probe

For measurement on flat surfaces, on shafts and in bores.

Skid radius lengthwise/transverse	30/1.95 mm
Measuring range	100 μm
With 2 $\mu\text{m}/90^\circ$ stylus tip	Art.no. 240 005
With 5 $\mu\text{m}/90^\circ$ stylus tip	Art.no. 240 000
Oil resistant with 2 $\mu\text{m}/90^\circ$ stylus tip	Art.no. 1000 8327
Oil resistant with 5 $\mu\text{m}/90^\circ$ stylus tip	Art.no. 240 008

T1E one skid probe with transverse skid

For length and transverse measurement on flat surfaces, on shafts and in bores.

Skid radius lengthwise/transverse	30/30 mm
Measuring range	100 μm
With 2 $\mu\text{m}/90^\circ$ stylus tip	Art.no. 1002 0277
With 5 $\mu\text{m}/90^\circ$ stylus tip	Art.no. 240 022

T3E one skid probe

With large measuring range for very rough surfaces.

Skid radius lengthwise/transverse	30/1.95 mm
Measuring range	300 μm
With 5 $\mu\text{m}/90^\circ$ stylus tip	Art.no. 243 961

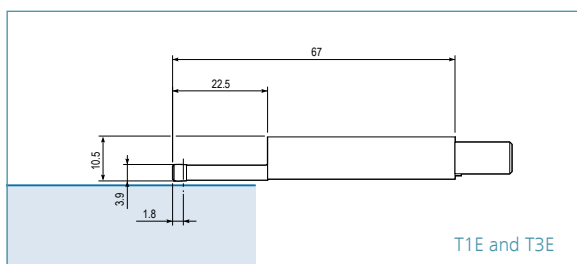

T1E and T3E

TKO 50 one skid probe

Offset skid for bores from 2 mm diameter.

Skid radius lengthwise/transverse	30/0.925 mm
Measuring range	50 μm
With 2 $\mu\text{m}/90^\circ$ stylus tip	Art.no. 224 444
With 5 $\mu\text{m}/90^\circ$ stylus tip	Art.no. M0435 023

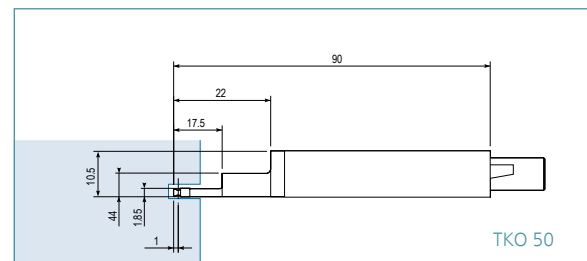

TKO 50

T1K one skid probe

For measurement on concave and convex surfaces.

Skid radius lengthwise/transverse	0.2/3.95 mm;
Skid depth	3 mm
Measuring range	100 μm
With 2 $\mu\text{m}/60^\circ$ stylus tip	Art.no. 257 413
With 5 $\mu\text{m}/90^\circ$ stylus tip	Art.no. 256 504

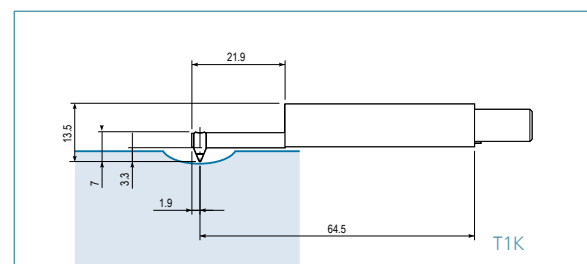

T1K

TKPK 100 two skid probe

For measurement on cold-rolled sheets (EN 10049).

Wear-reduced skids with DLC coating.

Skid radius lengthwise/transverse	50/3 mm
Measuring range	100 μm
With 5 $\mu\text{m}/90^\circ$ stylus tip	Art.no. 235 730

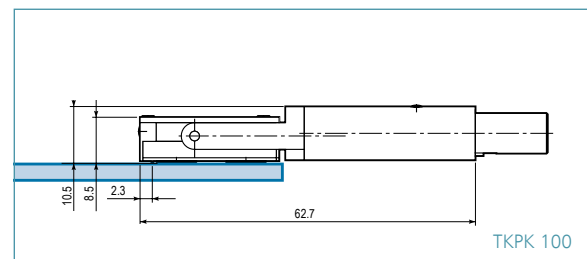

TKPK 100

Dimensioning in drawings in mm.

Universally applicable roughness measuring system



HOMMEL-ETAMIC T8000 R120-400 with optional wavecontrol™ basic control panel and measuring table MT1 XYO

The PC-based T8000 R measuring instruments are designed for demanding tasks in professional roughness metrology. Each one meets international standards and can be used both in production and in the metrology lab.

Its state of the art design allows varying expansion levels of the measuring station configuration and offers upgrade possibilities for both topography and contour measurement

Highlights HOMMEL-ETAMIC T8000 R

- High-precision traverse unit for skidless measurement
- Modular structure
- PC-based evaluation unit
- Robust Gauss filter according to ISO/TS 16610-31
- Many special parameters from the automotive industry



The probe can be swiveled 90° for measurements on recessed surfaces or between collars. The surface is scanned perpendicular to the traversing direction without complex conversion.



The roughness probe is attached either to the drive bar or underneath the traverse unit. This guarantees maximum flexibility for use in a wide range of measuring tasks.

HOMMEL-ETAMIC T8000 R system features

- Calculation of all common roughness, waviness and profile parameters
- Continuous further development of the software with regard to new standards/changes in standards
- Traverse length 120 mm for roughness and waviness measurement
- Suitable for measurement positions with difficult access thanks to the positioning accuracy of the drive bar
- Stable and robust motorized measuring column for automatic probe positioning
- Universally usable roughness probe with exchangeable probe arms for different measuring tasks and special applications
- User friendly software with individual measuring programs and clearly arranged operating structure

Model	Vert.measuring range*	Min. resolution*	Measuring range/hor. resolution	Vertical travel	Granite plate	Topography option	Twist option	Contour option
T8000 R120-400	±300 or ±600 µm	1 nm or 2 nm	120 mm/0.1 µm	400 mm	780 x 500 mm	yes	yes	yes
T8000 R120-800	±300 or ±600 µm	1 nm or 2 nm	120 mm/0.1 µm	800 mm	1000 x 500 mm	yes	yes	yes

* Smallest measuring range and depending on roughness probe

Compact and precise contour measuring systems



HOMMEL-ETAMIC C8000-400 digital with optional measuring table MT1 XYO and vee-block

Our contour measuring systems are equipped with digital, high-resolution linear scales in the Z and X direction so that they are free of negative, analog variables.

The C8000 digital contour measuring stations boast an optimum price/performance ratio and are designed for high-precision contour measurement.

Highlights HOMMEL-ETAMIC C8000 digital

- Maximum vertical measurement range: 60 mm
- Interactive control of the measuring station
- High level of continuous measuring accuracy thanks to digital measuring system
- Powerful analysis software
- Processing of several profiles



The C8000 digital contour measuring stations feature a modern, digital measuring system. The resolution remains high throughout the entire measuring cycle and provides maximum repeatability and measurement accuracy even with critical contour features.

- Motorized probe arm lift and stroke limitation
- Quick release fastener for simple probe arm change
- Manual probing force adjustment
- Automatic measurement runs

HOMMEL-ETAMIC C8000 digital system features

- Vertical measuring range/resolution: 60 mm/50 nm
- wavecontour™ digital probing system with digital linear scales in the Z and X-axis
- Large measuring volume
- Wizard for easy system calibration
- Wide range of easy-to-replace probe arms for various applications
- Compact measuring station configuration for all standard contour measuring tasks

Model	Vert. measuring range	Min. resolution	Measuring range/horizontal resolution	Vertical travel	Granite plate	Top/bottom measurement option	Roughness option	Topography option	Twist option
C8000-400 digital	60 mm	50 nm	120 mm/0.1 µm	400 mm	780 x 500 mm	no	no	no	no
C8000-800 digital	60 mm	50 nm	120 mm/0.1 µm	800 mm	1000 x 500 mm	no	no	no	no
Contour measuring systems that can be upgraded to additional roughness measurement									
T8000 C120-400 digital	60 mm	50 nm	120 mm/0.1 µm	400 mm	780 x 500 mm	no	yes	yes*	yes*
T8000 C200-800 digital	60 mm	50 nm	200 mm/0.01 µm	800 mm	1000 x 500 mm	no	yes	yes*	yes*

* In conjunction with the optional roughness measurement

Contour measuring systems with electronic probe arm recognition



HOMMEL-ETAMIC T8000 C120-400 digiscan with optional measuring table MT1 XYO and vee-block

The C8000 digiscan contour measuring systems provide state-of-the-art technology, assuring safety in the design of the test processes, as well as ease of operation and fully reliable measuring results.

Thanks to intelligent probe arms, the contour probe system detects which probe arm is installed and automatically loads the correct system measuring conditions. This helps prevent operational errors from occurring.

Highlights HOMMEL-ETAMIC C8000 digiscan

- Vertical measurement range: 60 or 90 mm
- Electronic probe arm detection using RFID technology
- Optional top/bottom probing as well as diameter and thread measurement
- Reliable measurement of small geometric features
- Extensive analysis functions



The probe arms with magnetic holder and electronic probe arm identification are automatically assigned to the right measuring program.

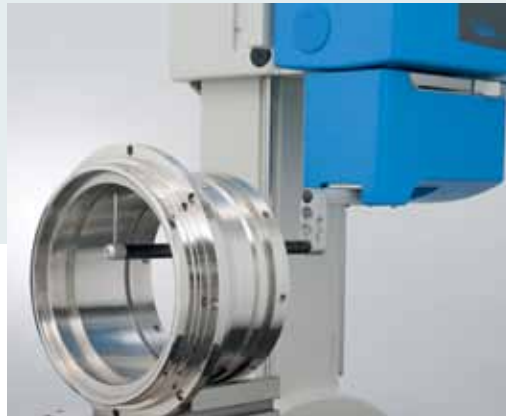

- Automatic setting of the measuring conditions
- Electronic probing force setting
- Electronically dampened lowering of the stylus tip to prevent stylus tip defects
- Automatic measurement runs



Dual-tip probe arms enable optional top/bottom probing in one measuring run and are used to determine the inside diameter.

HOMMEL-ETAMIC C8000 digiscan system features

- Vertical measuring range/resolution: 60 or 90 mm/50 or 75 nm
- wavecontour™ digiscan probing system with automatic probe arm detection
- The use of RFID technology eliminates the need to manage probe arms manually
- Motorized probe arm lifting/lowering
- Adjustable stroke limit
- Automatic measuring and evaluation
- Processing of several profiles
- Probe arms can be quickly replaced for different measuring tasks

Model	Vert. measuring range	Min. resolution	Measuring range/horizontal resolution	Vertical travel	Granite plate	Top/bottom measurement option	Roughness option	Topography option	Twist option
C8000-400 digiscan	60/90 mm	50/75 nm	120 mm/0.1 µm	400 mm	780 x 500 mm	yes	no	no	no
C8000-800 digiscan	60/90 mm	50/75 nm	120 mm/0.1 µm	800 mm	1000 x 500 mm	yes	no	no	no
Contour measuring systems that can be upgraded to additional roughness measurement									
T8000 C120-400 digiscan	60/90 mm	50/75 nm	120 mm/0.1 µm	400 mm	780 x 500 mm	yes	yes	yes*	yes*
T8000 C200-800 digiscan	60/90 mm	50/75 nm	200 mm/0.01 µm	800 mm	1000 x 500 mm	yes	yes	yes*	yes*

* In conjunction with the optional roughness measurement

Combined roughness and contour measuring systems



HOMMEL-ETAMIC T8000 RC120-800 digital with optional wavecontrol™ basic control panel, measuring table MT1 XYO and vee-block

The optimum combination for roughness and contour measurement is provided by the intelligent integration of both measurement systems. Roughness and contour are evaluated by two separate probing systems.

The drive bar positions the roughness probe even in difficult to access measuring positions. The contour probe is easy to change and can be operated parallel to the roughness probe if necessary.

Highlights HOMMEL-ETAMIC T8000 RC

- Universal roughness and contour measuring system
- Easily interchangeable probing systems
- Roughness measurement over the whole traverse length
- Automatic measuring runs with motorized lowering/lifting of the probe
- Attachment of the roughness probe either to the drive bar or underneath the traverse unit



The T8000 RC digiscan offers a large measuring stroke for complex contour measurements. Probe arms with magnetic holder are easy to replace and allow flexible extension of the vertical measuring range.

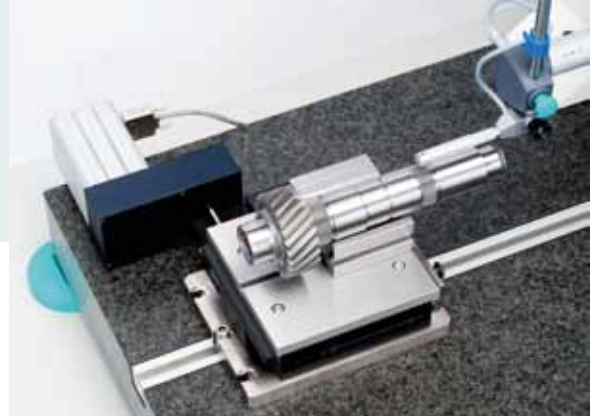

A broad range of roughness probes, accessories and software options allow for a wide variety of applications. For example, topography features can be specified as an option.

HOMMEL-ETAMIC T8000 RC system features

- Uniform user interface for roughness and contour evaluations
- Calculation of all common roughness, waviness and profile parameters
- Evaluation of geometric characteristics such as distances, angles and radii
- Traverse length 120 mm for roughness, waviness and contour measurements
- Evaluation of roughness and contour characteristics in one measurement log
- Traverse unit with high guiding accuracy and digital glass scale for exact measurement results
- Stable and robust motorized measuring column for automatic probe positioning
- Digital probing systems for contour measurement: wavecontour™ digital with quick fastener or wavecontour™ digiscan with magnetic holder for fast and secure changing of the probe arms

Model	Vert. measuring range*	Min. resolution*	Measuring range/hor. resolution	Vertical travel	Granite plate	Topography option	Twist option
T8000 RC120-400 digital	R: ± 300 or ± 600 μm C: 60 mm	R: 1 or 2 nm C: 50 nm	120 mm/0.1 μm	400 mm	780 x 500 mm	yes	yes
T8000 RC120-800 digital	R: ± 300 or ± 600 μm C: 60 mm	R: 1 or 2 nm C: 50 nm	120 mm/0.1 μm	800 mm	1000 x 500 mm	yes	yes
T8000 RC120-400 digiscan	R: ± 300 or ± 600 μm C: 60/90 mm	R: 1 or 2 nm C: 50/75 nm	120 mm/0.1 μm	400 mm	780 x 500 mm	yes	yes
T8000 RC120-800 digiscan	R: ± 300 or ± 600 μm C: 60/90 mm	R: 1 or 2 nm C: 50/75 nm	120 mm/0.1 μm	800 mm	1000 x 500 mm	yes	yes

* R = roughness, C = contour

High resolution roughness and contour measurement in one run



HOMMEL-ETAMIC surfscan with optional vee-block

Roughness and contours are recorded simultaneously with a high-resolution, digital probing system. As a result, this measuring system provides the optimal solution for demanding measuring applications in the metrology lab and in production. The geometric characteristics and roughness parameters are evaluated in one run. With its extraordinary price/performance ratio, this system offers application possibilities that are usually only covered by much more complex laboratory systems.

Highlights HOMMEL-ETAMIC surfscan

- Time-saving thanks to simultaneous measurement of roughness and contour
- Highest repeatability even for critical measuring tasks
- Time-consuming alignment of the reference plane is no longer necessary when measuring roughness
- RFID technology for automatic detection of the probe arms and setting of the correct measuring parameters

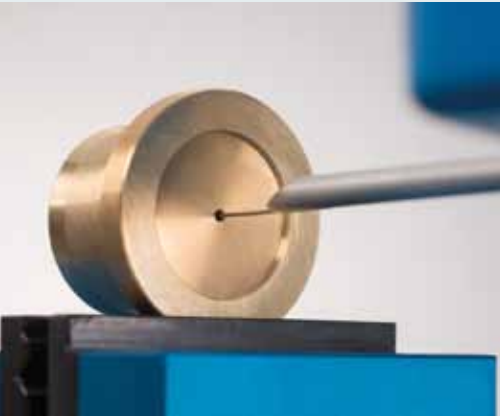

Precision probe arm positioning allows automatic measurement runs to be performed even on small workpieces and in small bores.



Probe arms are quick and easy to replace thanks to magnetic mounting points. Additionally, probe arm installation is automatically detected using RFID technology and assigned to the correct measuring task by the software.



The large measuring stroke and wide range of probe arms for specific measurement tasks open up a variety of application possibilities.

HOMMEL-ETAMIC surfscan system features

- Universal measuring station for quality control in production or in the metrology lab
- Modular system design for individual configurations
- Intuitive, easy-to-use software for integrated evaluation of roughness and contour features in a customizable measurement log
- Only one probing system for roughness and contour
- Roughness measurement on inclined or curved surfaces with a resolution of 6 nm in the 6 mm measuring range
- The wide measuring range means there is no need to align the probing system with the workpiece surface
- Magnetic probe arm holder for fast and secure changing of the probe arms
- Extensive software functions for the evaluation of roughness and contour
- Can be extended with other probing systems, e.g. to enlarge the contour measuring range with the wavecon™ digital/digiscan probing systems or with roughness probes for specific roughness measurement tasks

Model	Vert. measuring range	Min. resolution	Measuring range/hor. resolution	Vertical travel	Granite plate	Topography option	Twist option
surfscan 120-400	6 or 12 mm	6 or 12 nm	120 mm/0.1 µm	400 mm	780 x 500 mm	yes	yes
surfscan 120-800	6 or 12 mm	6 or 12 nm	120 mm/0.1 µm	800 mm	1000 x 500 mm	yes	yes

Simultaneous roughness and contour measurement in the nanometer range



HOMMEL-ETAMIC nanoscan 855 with optional contour standard KN8

The nanoscan 855 offers two measuring systems in one, ensuring universal, flexible use for all measurement tasks in the field of surface measuring technology – saving time and money.

With its high resolution, large presence and highly accurate straightness guide, this exceptionally precise measuring system is suitable for the finest of surface roughness features as well as for determining micro-geometric features or contours with a large presence.

Highlights HOMMEL-ETAMIC nanoscan 855

- RFID technology with
 - automatic setting of probe force and measuring conditions
 - automatic assignment of probe arms to each measuring task
- Highly precise probe positioning
- Top/bottom or inner/outer measurement
- Thread measurement with automatic evaluation



The combined measurement and evaluation of roughness and contour is automated in a single measuring run.



Dual-tip probe arms with double stylus tips enable automated measurement in the conventional and overhead position. As a result, it is possible to determine the diameter of bores.



The entire system is calibrated via a ball standard and an automated measurement run.

HOMMEL-ETAMIC nanoscan 855 system features

- Ultra-precision, opto-mechanical measuring system with high resolution and large measuring range for measurements on curved or inclined surfaces
- Ergonomic measuring station design with integrated granite plate and active level regulation
- Automatic measuring runs thanks to fast, CNC-controlled measuring axes for highest productivity
- New evaluation possibilities: top/bottom measurement, inside diameters, parallelism and angularity of geometric elements from several profiles
- Topography measurement with optional Y-axis and large measuring stroke as well as high resolution
- Easy calibration method with only one sphere standard and an automatic calibration measuring run
- Precise, magnetic probe arm holder for fast and secure changing of probe arms; insertion either in „down“ or „up“ probing direction
- Extensive range of probe arms for a large range of measuring tasks
- Optional cover for reducing environmental influences

Model	Vert. measuring range*	Min. resolution*	Measuring range/hor. resolution	Vertical travel	Granite plate	Topography option
nanoscan 855	24 or 48 mm	0.6/1.2 nm	200 mm/0.01 µm	550 mm	850 x 600 mm	yes

EVOVIS – evaluation software for roughness and contour



Measuring station control

EVOVIS software is easy to use and offers a standardized interface for roughness and contour measurement, regardless of the configuration of the device.

Simple icons, supported by comprehensive help functions, allow the operator to use the efficient measurement and evaluation tools according to their own requirements.

In the workpiece-specific test plan, several measuring tasks can be summarized using different measuring conditions, ensuring that all of the features to be checked remain in one overview and are documented in the same log.

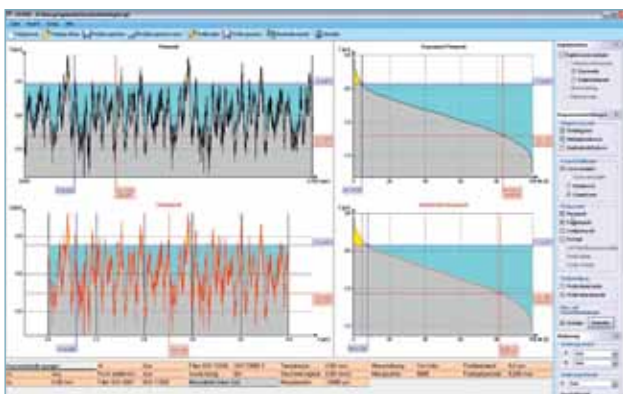

Profile analysis of roughness and waviness

Highlights HOMMEL-ETAMIC EVOVIS for roughness measurement and evaluation

- Interactive profile analysis functions for evaluating surface parameters
- Evaluation of the measurement results in accordance with tolerance specifics displayed in a compact form
- Measuring station control: all of the information in one view, reliable operation of all manual and automatic functions
- Individual test plan creation
- Wizard for selecting the measuring conditions
- All common roughness and waviness parameters in accordance with ISO 4287 and other ISO and national standards (DIN, JIS, Motif, etc.)
- Robust Gaussian filter in accordance with ISO/TS 16610-31
- Optionally can be extended to include function-oriented parameters such as dominant waviness (VDA 2007), twist parameters (MBN 31007-07) and other factory standard-specific parameters
- Open design of the print log
- Electronic archiving of logs with PDF printout and automatic save function



Wizard for selection of measuring conditions



Contour evaluation

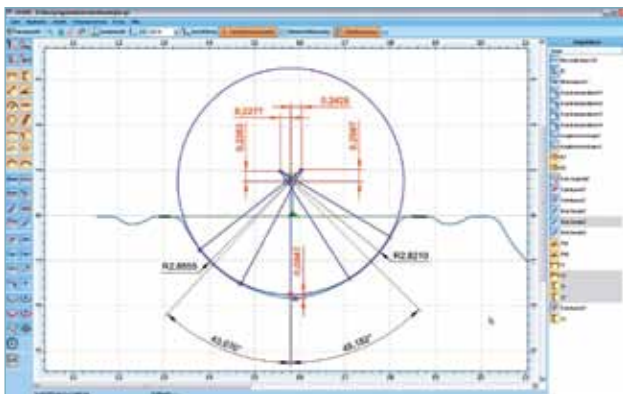

Gothic arcs

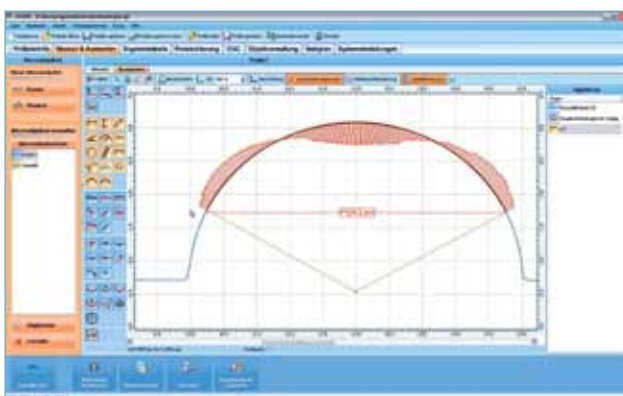

Nominal-actual comparison with profile deviation

EVOVIS is the quick and reliable way to evaluate geometric features of workpieces, such as radii, angles or distances.

Additional evaluation tools are offered by the line profile deviation with variable tolerance range, the comparison option with stored nominal profiles, as well as the automatic evaluation of complex geometric elements such as Gothic arcs or workpiece edges.

Precision fitting methods, various options for forming help elements, and definition options for the coordinate origin also enable complex evaluations to be performed.

Highlights HOMMEL-ETAMIC EVOVIS for contour measurement and evaluation

- Intelligent measuring station control
- Individual test plan creation
- Processing of several profiles/features in one test plan
- Icon-based contour features for quick test plan creation
- Help elements such as references, points, lines or co-ordinate systems
- Automatic alignment functions of the measured profile
- Automatic evaluation run with clear workflow
- Powerful zoom functions
- Automatically generated results table
- Graphic representation of line profile deviations with variable tolerance range
- Morphological filter
- Evaluation of complex geometric elements such as Gothic arcs or edge geometries
- Open design of print logs
- Electronic archiving of logs with PDF printout and automatic save function

Combined evaluation of roughness and contour

EVOVIS supports innovative, combined, measurement systems and enables the integrated evaluation of roughness and contour characteristics.

The evaluation of roughness parameters can be determined interactively anywhere in the contour profile. The roughness profile can also be shown graphically.

Additionally the roughness and contour characteristics can be displayed in a table and can also be evaluated statistically.

Highlights HOMMEL-ETAMIC EVOVIS for combined roughness and contour measuring systems

- Interactive roughness evaluation on the contour profile
- Roughness evaluation on straight lines, inclines and radii segments
- Individual definition of evaluation length and filter setting for the roughness evaluation
- Retrospective roughness evaluation possible on measured profiles

Customer Johnson Corp.	Work piece Ball screw	
Order Initial sample testing	Drawing number 1254621-02	
Operator Mike Schmidt	Serial number n.a.	
Comment First sample		

Name	Unit	Lower limit value	Upper limit value	Nominal value	Value	Bar chart
Contour 1						
Phi1	°	44,000	46,000	45,000	42,223	
Phi2	°	44,000	46,000	45,000	45,454	
X1	mm	0,1800	0,2000	0,1900	0,1841	
X2	mm	0,1800	0,2000	0,1900	0,1981	
Z1	mm	0,1000	0,3000	0,2000	0,2028	
Z2	mm	0,1000	0,3000	0,2000	0,1950	

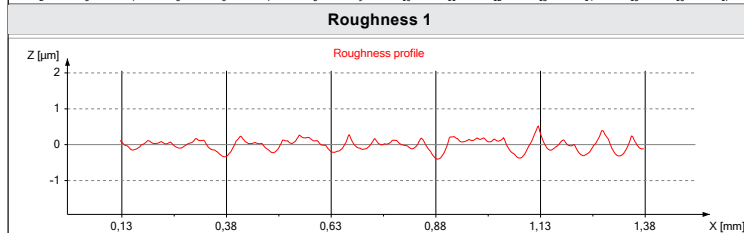
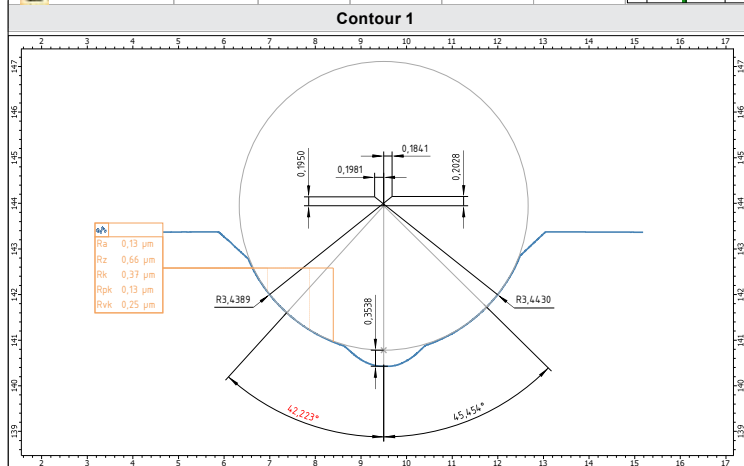

Individual design of print logs:
dimensions and roughness parameters evaluated simultaneously

Software options for EVOVIS



CNC control

Automatic runs: CNC control

A CNC measuring run needs a lot less time than a manual measurement sequence and supplies operator-independent, reproducible results.

This option allows complex CNC runs and evaluations to be programmed quickly and easily. The run commands are selected via mouse click and the necessary parameters are automatically set. The created program run is displayed clearly in a graphic workflow.

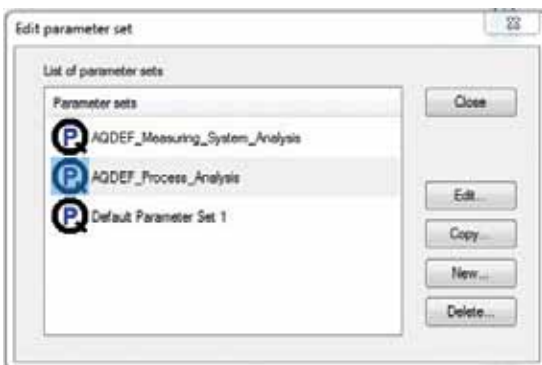

qs-STAT® data export interface

The data export interface supports the Q-DAS ASCII transfer format for the exchange of quality information via Q-DAS software modules. Predefined parameter sets and the possible use of predefined catalogs simplify set-up of the data interface.

The interface is certified by Q-DAS according to AQDEF specifications (Automotive Quality Data Exchange Format).

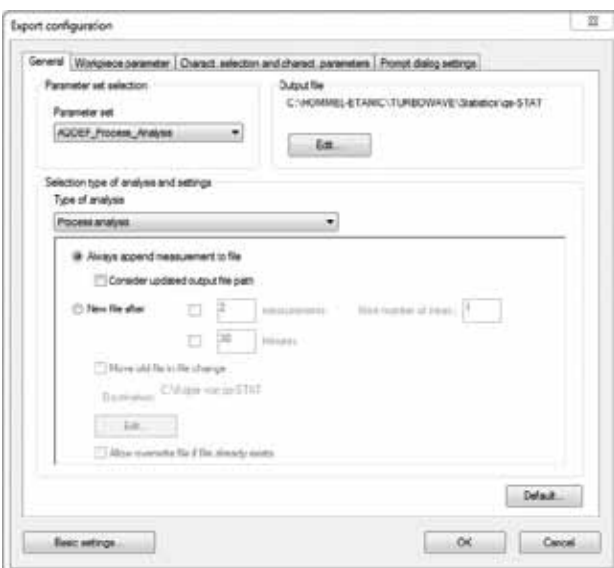

qs-STAT® data export

Topography evaluation: option for roughness measurement

HOMMEL MAP 3D topography analysis software offers extensive evaluation possibilities for profile and surface data. Both the T8000 and the nanoscan can be up-graded for topography measurement. A „Y“ positioner is necessary in addition to the software (see page 42).

Highlights HOMMEL-ETAMIC HOMMEL MAP

- Intuitive structure of the analysis documents
- Pre-processing of the measured data: alignment, filtering and form removal
- Automatic recalculation after changing evaluation steps
- Extensive online help
- Standards for evaluation of 2D parameters
- ISO/TS 25178 standard for 3D parameters (only HOMMEL MAP expert and premium)
- Extensive metrological and scientific filter possibilities
- Extensive graphic and analytical studies

Depending on the requirements, HOMMEL MAP 3D evaluation software is available in three different versions each one adding greater capabilities than the last.

HOMMEL MAP basic

- Document management
- Interactive studies of 3D objects
- 2D parameters according to ISO 4287
- Distance measurement, step height evaluation

HOMMEL MAP expert

basic functions plus

- Evaluation of profile series
- Rk parameters, Motif parameters, 2D parameters automotive
- 3D parameters
- Joining of multiple profiles
- FFT analysis, frequency spectrum and autocorrelation
- Morphological filtering on 3D objects
- Difference between two surfaces

HOMMEL MAP premium

expert functions plus

- Extensive studies of surface series
- Studies on binary surfaces (grains)
- Multilayer surfaces

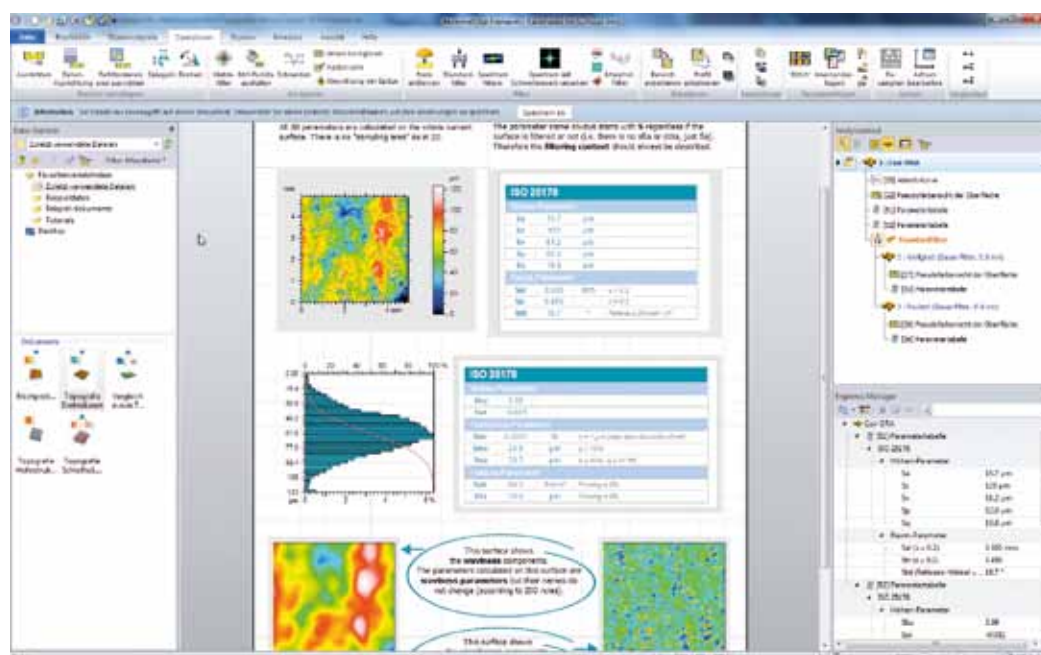

Topography evaluation

Other options for roughness measurement

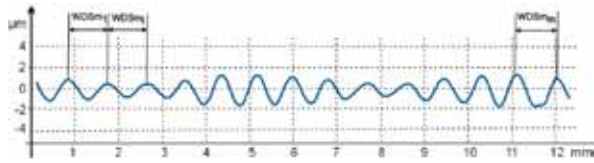

Horizontal waviness parameter WDSm

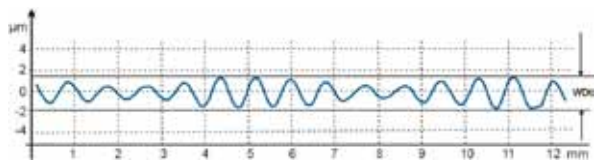

Total profile height WDt

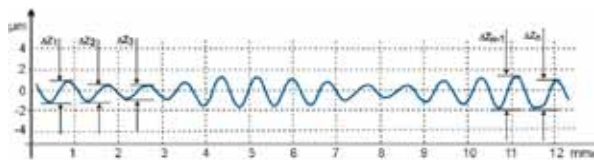

Medium height of profile elements WDc

Dominant waviness according to VDA 2007

The primary profile is checked for dominant waviness. The evaluation method automatically recognizes any existing periodic characteristics, extracts the waviness profile (WD profile) and derives the parameters WDSm, WDt and WDc.

The following functional behavior can be tested, for example, with the dominant waviness analysis:

- Static tightness
- Dynamic tightness
- Noise emission
- Avoidance of increased wear or malfunctions
- Pre-processing conditions

Twist evaluation according to MBN 31 007-07

Twist structures at sealing surfaces occur during the machining process and impair the sealing function between the shaft and the sealing ring.

The most important properties of these surface structures are measured three-dimensionally and the parameters relevant to the tightness determined:

Number of threads	DG
Twist depth	Dt [µm]
Period length	DP [mm]
Feed cross section	DF [µm ²]
Feed cross section per revolution	DFu [µm ² /r]
Contact length	DLu [%]
Twist angle	Dγ [°]

TwistLive® analysis method (patented)

With this modern analysis method the normal measurement time may be reduced by up to 75%. During the measuring process, a results forecast of the twist parameters is already possible – live !

For twist measurement, the optional rotary traverse unit (see page 41) is required.

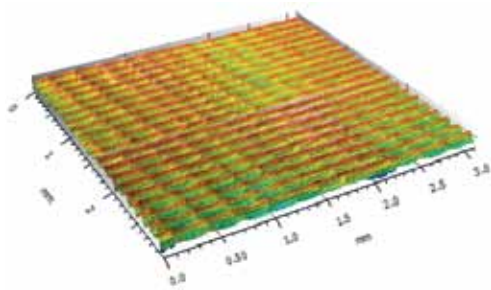

Measured surface with twist structure

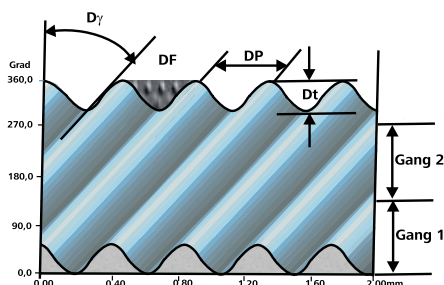

Twist parameters

Probe sets for roughness parameters

The TKU probe sets are versatile to use because they replace up to three conventional standard probes and therefore offer a low-cost alternative. The probe sets can be extended at any time with additional probe arms.

The probe sets contain

- Basic probe, skid (TKU 300/600 only), probe protection
- TS1 probe arms for bores
- TS2 probe arm (TKU 300/600 only)
- TS1T probe arm for grooves
- TS1D probe arm for collars and faces

TKU 100 probe set $\pm 100 \mu\text{m}$

With $2 \mu\text{m}$ stylus tip Art.no. 256 658
 With $5 \mu\text{m}$ stylus tip Art.no. 256 500

TKU 300/600 probe set $\pm 300/600 \mu\text{m}$

With $2 \mu\text{m}$ stylus tip Art.no. 256 657
 With $5 \mu\text{m}$ stylus tip Art.no. 230 450



TKU 300/600 probe set

TS1 or TS2 probe arm

For bores from 4 or 5 mm diameter;
 max. horizontal tracing depth 33 or 78 mm.

TS1 with $2 \mu\text{m}/90^\circ$ stylus tip Art.no. 240 805
 TS1 with $5 \mu\text{m}/90^\circ$ stylus tip Art.no. 230 475
 TS2 with $2 \mu\text{m}/90^\circ$ stylus tip Art.no. 240 156
 TS2 with $5 \mu\text{m}/90^\circ$ stylus tip Art.no. 230 480

TS1T probe arm

For grooves with max. vertical/horizontal tracing depth of 10/33 mm.

With $2 \mu\text{m}/90^\circ$ stylus tip Art.no. 256 624
 With $5 \mu\text{m}/90^\circ$ stylus tip Art.no. 231 289

TS1D probe arm

For collars, directly on end faces and bores from 5 mm diameter; distance from end face to probing point 0.2 mm; max. horizontal tracing depth 33 mm.

With $2 \mu\text{m}/60^\circ$ stylus tip Art.no. 240 160
 With $5 \mu\text{m}/60^\circ$ stylus tip Art.no. 231 291

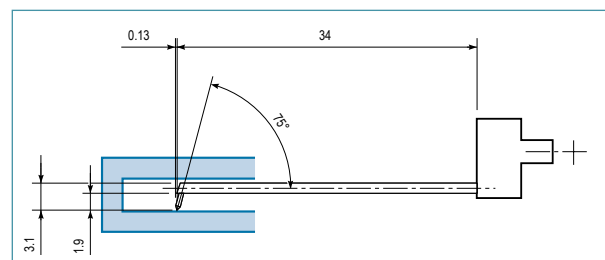
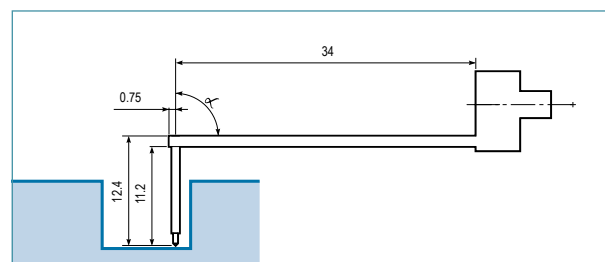
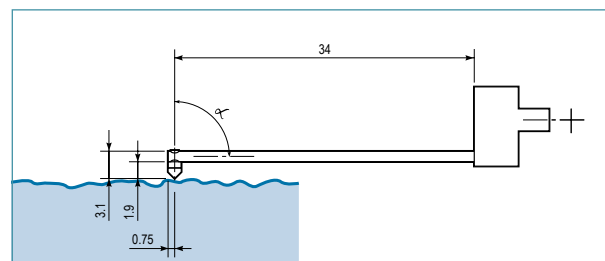

Dimensioning in drawings in mm. Pages 34 – 39 excerpt from our extensive range of available probes and probe arms. Additional models on demand.

Probe sets with magnetic adapter

The TKU 300 TSM probe arm set includes a magnetic adapter with 3-point support for fast and easy change out of the probe arms. In case of collision, the probe arm detaches itself from the roughness probe and thus prevents damage of the probe arm or roughness probe. The included probe arms cover the most common roughness measuring tasks.

The probe set contains

- Basic probe with magnetic adapter
- TSM1 probe arm for bores
- TSM1T probe arm for grooves
- TSM1D probe arm for collars and faces

TKU 300 TSM probe set $\pm 300 \mu\text{m}$

With $2 \mu\text{m}/90^\circ$ stylus tip Art.no. 1005 9997

With $5 \mu\text{m}/90^\circ$ stylus tip Art.no. 1006 5082



TKU 300 TSM probe set

TSM1 probe arm

For bores from 4 mm diameter;
max. horizontal tracing depth 33 mm.

With $2 \mu\text{m}/90^\circ$ stylus tip Art.no. 1006 0616

With $5 \mu\text{m}/90^\circ$ stylus tip Art.no. 1005 4119

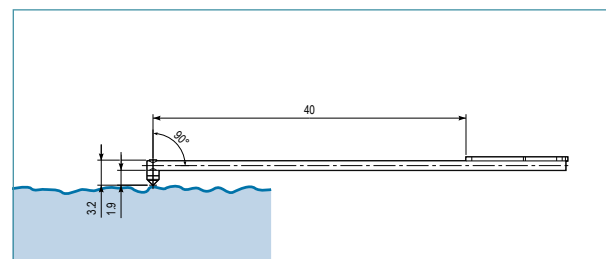

TSM1T probe arm

For grooves with max. vertical/horizontal tracing depth of 10/33 mm.

With $2 \mu\text{m}/90^\circ$ stylus tip Art.no. 1006 0617

With $5 \mu\text{m}/90^\circ$ stylus tip Art.no. 1006 5084

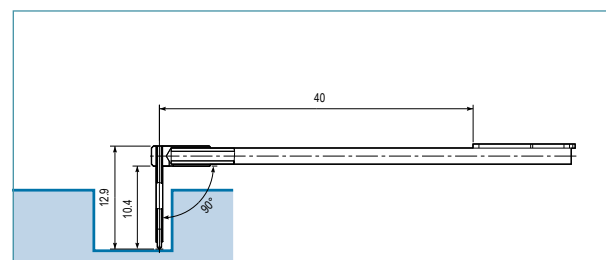

TSM1D probe arm

For collars, directly on end faces and bores from 5 mm diameter; distance from end face to probing point 0.2 mm; max. horizontal tracing depth 33 mm.

With $2 \mu\text{m}/60^\circ$ stylus tip Art.no. 1006 0618

With $5 \mu\text{m}/60^\circ$ stylus tip Art.no. 1006 5085

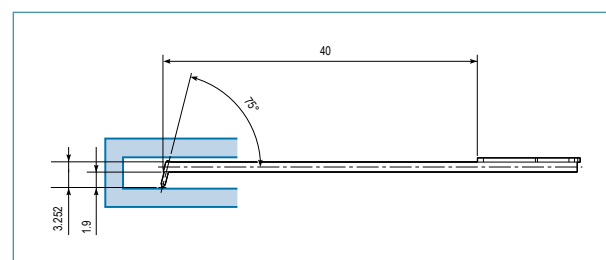

Dimensioning in drawings in mm.

Skidless probes for roughness, waviness and profile

With a measuring range of ± 300 or ± 100 μm and precise ruby bearings, the TKL probes are particularly well suited for fine roughness measurements. The probes are factory calibrated and provide long-term stability thanks to their dual spool system in the inductive converter.

TKL 300L probe

Standard probe for measurements of R, W and P profiles on plain surfaces, shafts and in bores from 4 mm.

Measuring range	± 300 μm
Max. horizontal tracing depth	30 mm
With 2 $\mu\text{m}/90^\circ$ stylus tip	Art.no. 1000 4132
With 5 $\mu\text{m}/90^\circ$ stylus tip	Art.no. 243 588

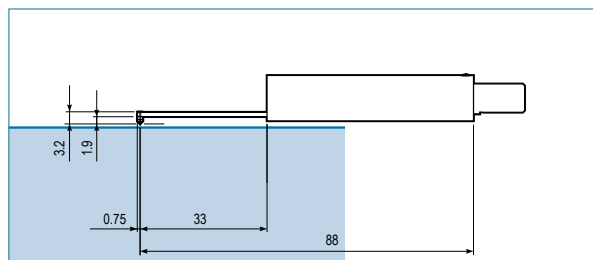

TKLK 100/5 probe

For measurements in small bores from 1 mm.

Measuring range	± 100 μm
Max. horizontal tracing depth	5 mm
With 2 $\mu\text{m}/90^\circ$ stylus tip	Art.no. 233 280
With 5 $\mu\text{m}/90^\circ$ stylus tip	Art.no. M0 435 035

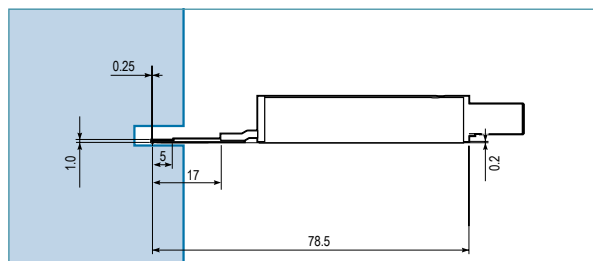

TKLT 100/17 probe

For measurements in grooves or on recessed surfaces.

Measuring range	± 100 μm
Vertical/horizontal tracing depth	13/17 mm
With 2 $\mu\text{m}/90^\circ$ stylus tip	Art.no. 552 726
With 5 $\mu\text{m}/90^\circ$ stylus tip	Art.no. 224 835

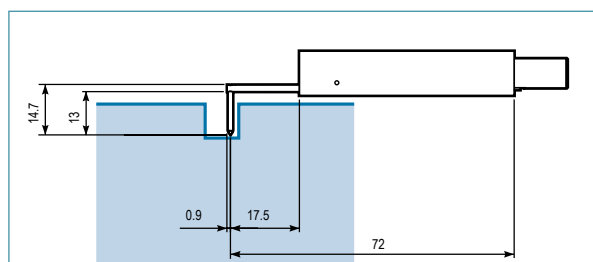

TKLQ 100/17 probe

With specific bearing for transverse measurements, e.g. in grooves or between collars.

Measuring range	± 100 μm
Max. horizontal tracing depth	17 mm
With 2 $\mu\text{m}/90^\circ$ stylus tip	Art.no. 231 207
With 5 $\mu\text{m}/90^\circ$ stylus tip	Art.no. 1004 4932

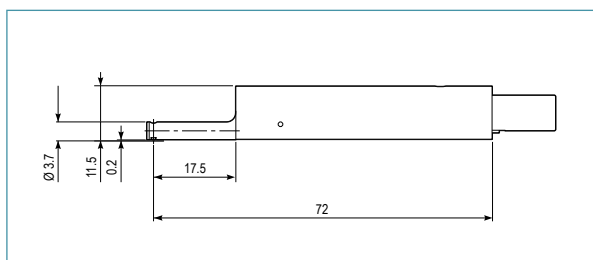

Dimensioning in drawings in mm.

wavecontour™ digital probe arms for contour measurement

TA-60 probe arm with carbide tip

For profile recording on very fine to coarse structures.

Probe arm Art.no. 243 700

Carbide stylus tip Art.no. 232 586

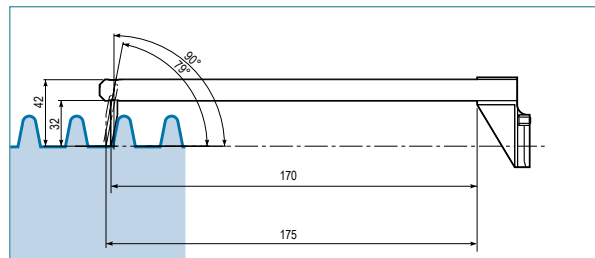

TA-60 probe arm with ruby ball

For measurements on radii or when mechanical pre-filtering is desired.

Probe arm Art.no. 256 497

Ruby ball stylus tip Art.no. 024 743

Adapter stylus tip Art.no. 230 695

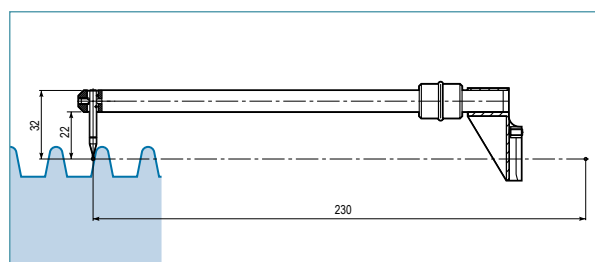

TA-60 probe arm for transverse measurements

Inner profile, e.g. internal gears, are made accessible by the transverse arm of 32.5 mm.

Probe arm Art.no. 256 785

Stylus tip Art.no. 284 039

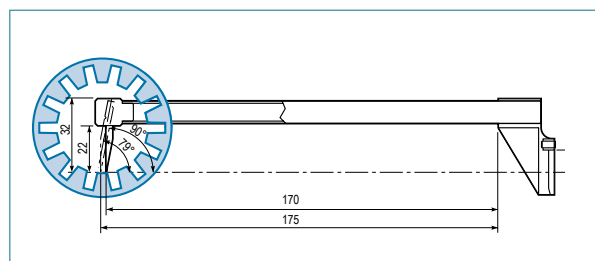

TA-60 probe arm for bores

With a maximum tracing depth of 35.8 mm.

For bores from 4.5 mm diameter.

Probe arm Art.no. 256 565

Stylus tip Art.no. M0 445 036

Bores from 4 mm Art.no. 1000 2710

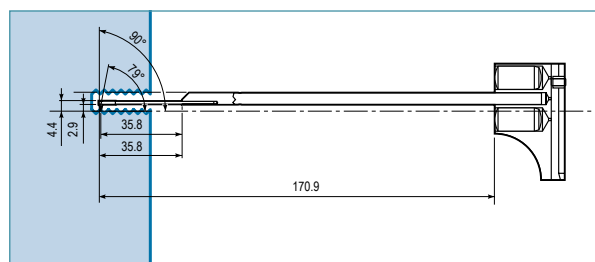

Stylus tips with ruby ball

Adapter M2 for stylus tip Art.no. 230 695

Stylus tip extension Art.no. 051 212

Stylus tip 0.25 mm Art.no. 051 342

Stylus tip 0.5 mm Art.no. 024 743

Stylus tip 1 mm Art.no. 051 208

Stylus tip 1.5 mm Art.no. 063 935

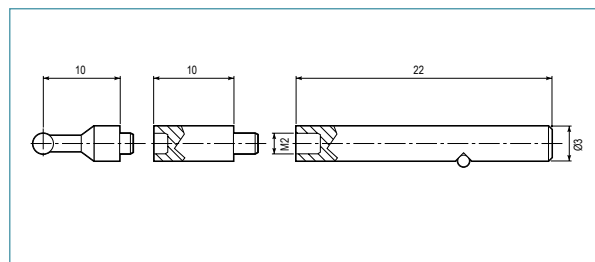

Dimensioning in drawings in mm.

wavecontour™ digiscan contour probe arms with magnetic coupling

TD-60 standard probe arm

With carbide tip for profile recording on very fine to coarse structures or with ruby ball for measurements on radii or if mechanical prefiltering is required.

Carbide probe arm	Art.no. 1005 7599
Carbide stylus tip	Art.no. 1005 3157
Ruby ball probe arm	Art.no. 1005 7670
Ruby ball stylus tip	Art.no. 1005 0760

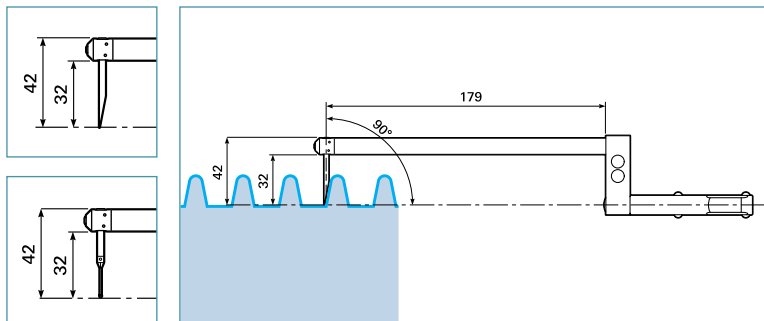

TD-90 probe arm at 1.5 times the length

For 90 mm measuring range.

Carbide probe arm	Art.no. 1005 7685
Carbide stylus tip	Art.no. 1005 3157
Ruby ball probe arm	Art.no. 1006 2155
Ruby ball stylus tip	Art.no. 230 695

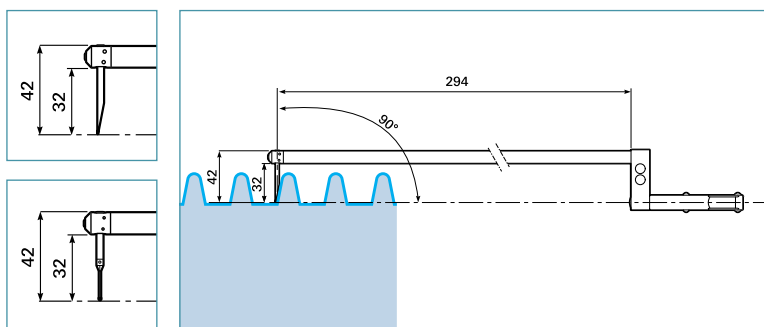

TD-60 probe arm for bores

Max. horizontal tracing depth 150 mm.

For bores from 12 mm.

Probe arm	Art.no. 1005 2855
Stylus tip	Art.no. 244 799

Max. horizontal tracing depth 39 mm.

For bores from 7 mm.

Probe arm	Art.no. 1005 8268
-----------	-------------------

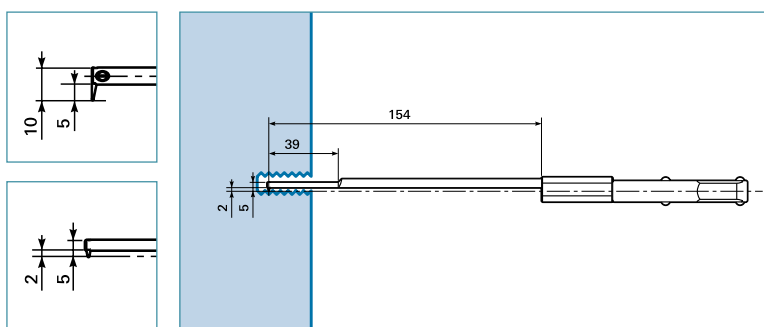

TD-60 dual-tip probe arms

For inner/outer measurement or top/bottom measuring.

T5 carbide probe arm	Art.no. 1005 8278
Stylus tip	Art.no. 1005 4412
T10 carbide probe arm	Art.no. 1005 8293
Stylus tip	Art.no. 1005 4413
T12 ruby ball probe arm	Art.no. 1005 7699
Stylus tip	Art.no. 1005 5974

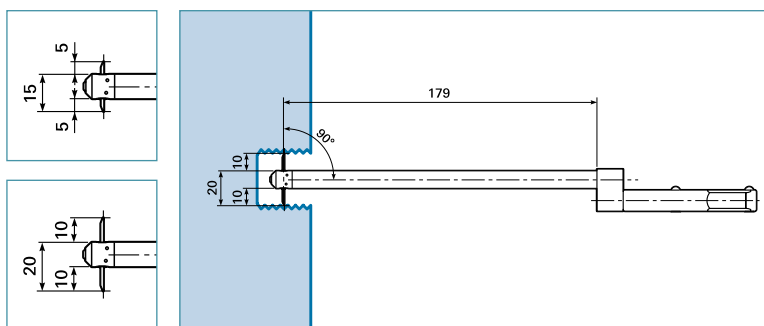

Dimensioning in drawings in mm.

Probe arms for combined roughness and contour measurement

WCN1 probe arm

With diamond tip for bores from 6.5 mm diameter.
 Max. horizontal tracing depth 60 mm
 With 2 µm/60° stylus tip Art.no. 1005 5687

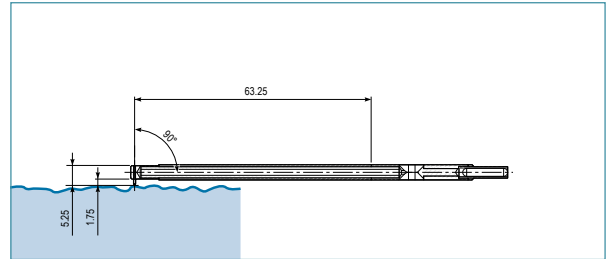

WCN1 probe arm for bores

With carbide tip for measurement of fine contours in bores.
 Max. vert./hor. tracing depth 4,5/60 mm
 With 20 µm/22° stylus tip Art.no. 1005 6630

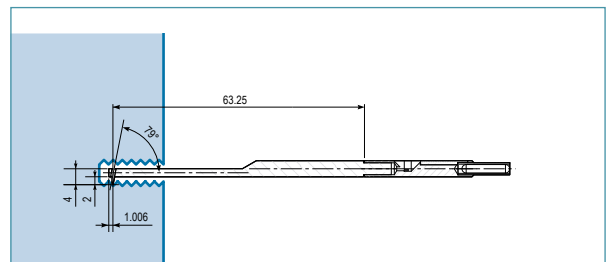

WCN1 probe arm with dual-tip

With carbide dual-tip.
 Max. vert./hor. tracing depth 5/60 mm
 With 20 µm/22° stylus tip Art.no 1005 5890
 With diamond dual-tip.
 Max. vert./hor. tracing depth 10/60 mm
 With 2 µm/60° stylus tip Art.no. 1004 6152

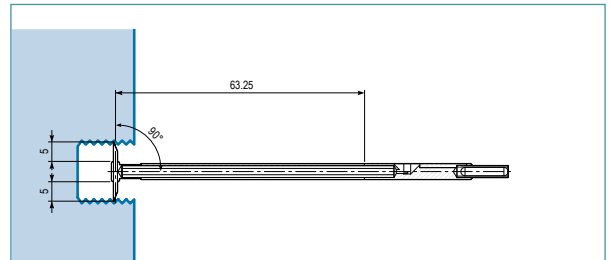
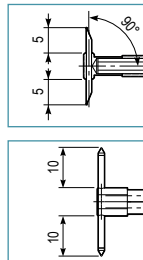

WCNT1 probe arm

With diamond tip for measurement in grooves or on recessed surfaces.
 Max. horizontal tracing depth 13/60 mm
 With 2 µm/60° stylus tip Art.no. 1005 5688

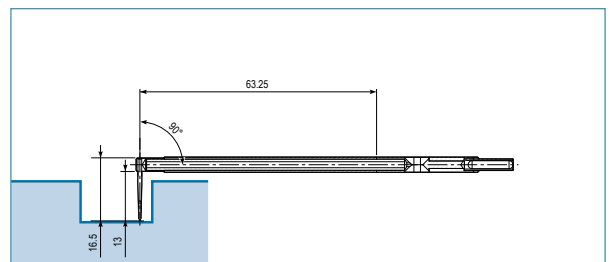

WCNT1T probe arm

With carbide tip.
 Max. vertical tracing depth 25 mm
 With 20 µm/15° stylus tip Art.no. 1006 6658
 Max. vertical tracing depth 13 mm
 With 20 µm/15° stylus tip Art.no. 553 734
 With ruby ball.
 Max. vertical tracing depth 7 mm
 With ruby ball Ø 0.5 mm Art.no. 1002 6503

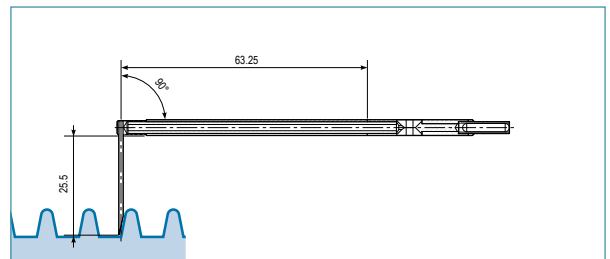
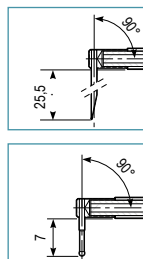

Dimensioning in drawings in mm.

Accessories for adapting the probing system to the measuring task

PHZ skid probe holder

For holding skid probes because the skid of the probe must adapt to the form deviation of a surface. The skid therefore forms the reference plane for the roughness measurement. All roughness parameters are measured with skid probes.

Art.no. 240 211



FHZ skidless probe holder

To hold skidless probes so that the stylus tip can measure the form deviations correctly. Skidless probes are used to determine roughness, waviness and form deviations.

Art.no. 240 215



FHZ rotatable skidless probe holder

Rotatable by 360° in steps of 15°.

For measurements overhead and on vertical surfaces.

Art.no. 244 891



AZZ probe extensions

Also suitable for mobile roughness measuring devices.

55 mm	Art.no. M0 435 041
100 mm	Art.no. M0 435 042
150 mm	Art.no. M0 435 043
200 mm	Art.no. M0 435 044



HAA holder

Twist-protected holder for fixed alignment of the roughness probe.

HAA150 Art.no. M0 435 127

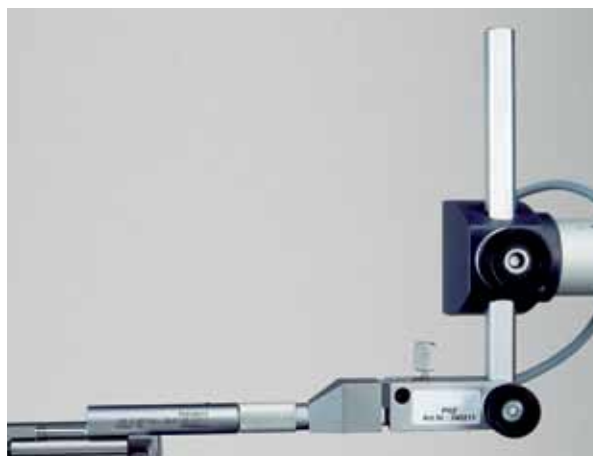

Probe adapter

Enables the operation of roughness probes under the traverse unit, alternatively to position on the drive bar.

Art.no. 240 754

Rotary traverse unit waverotor™

For roughness measurements on cylindrical workpieces in circumferential direction. Workpiece held by chuck or optional clamping jaws.

Art.no. 999 061

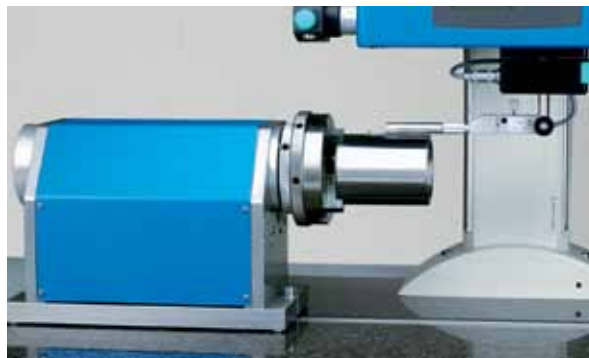
**wavecontrol™ basic control panel**

For convenient one-handed user control of the measuring system. Function keys for the most frequent operating functions; joystick for fine control of the axis movements; emergency stop switch close at hand.

Art.no. 1002 5181

**GTR instrument table**

With integrated granite plate on passive damping elements; undercabinet for accommodating the PC, printer and measuring instrument electronics. Max. load 300 kg.

GTR4 for 780 x 500 mm granite plate Art. no. 235 626

GTR5 for 1000 x 500 mm granite plate Art. no. 239 303

Damping elements with active level regulation

Optional for benchtop or instrument tables.

For 780 x 500 or 1000 x 500 mm granite plates.

Regulates the horizontal alignment of the granite plate; automatic and independent of the workpiece weight.

LC-25 for GTR4 Art. no. 1003 8970

LC-50 for GTR5 Art. no. 1003 8509

LC-25 benchtop version for
780 x 500 mm granite plate Art. no. 240 785



GTR4 instrument table

Accessories for holding of workpieces

Measuring tables

For holding and positioning workpieces. Two coordinates adjustable ± 12.5 mm; rotatable: $\pm 5^\circ$ around the vertical axis.

MT1: 160 x 160 mm support area

XYO axis Art. no. M0 435 276

XY axis Art. no. M0 435 273

MT2: 100 x 100 mm support area

XYO axis Art. no. M0 435 278

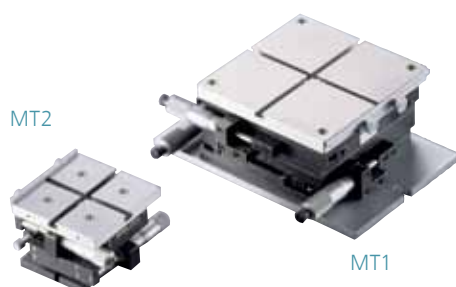

MT2

MT1

Vee-block

Four different sized, finely ground vees ensure a holding range of shafts and round workpieces with diameters between 1 and 150 mm.

Art. no. M0 435 084

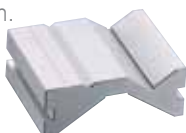

Y positioner

With motor drive for recording of topographies or for automatic positioning transversely to the probing direction. Load capacity approx. 30 kg. Guiding accuracy approx. 5 μ m. Max. trace width 50 mm. Smallest step size 2.0 μ m, optional with manual fine adjustment in X/Y-direction with a manual adjustment way of 25mm. 160 x 160 mm support area.

Y-positioner Art. no. 1005 2547

Y-positioner

with fine adjustment Art. no. 1005 2599



Parallel vices

Two small pairs of vees in the clamping jaws enable clamping of right-angled and cylindrical workpieces in horizontal or vertical position.

M32 Art. no. 050 968

M50 Art. no. 050 965

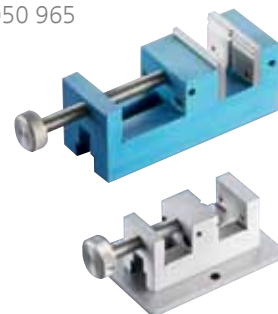

With flexible foot:

M32/GF32 Art. no. 050 966

M50/GF50 Art. no. 050 963



Angle vise

Completely precision ground. Angle adjustment in two axes with Nonius scale and screw for fine adjustment. Horizontal swivel range 360°, vertical swivel range $\pm 60^\circ$. Jaw width 70 mm, clamping range 80 mm.

Art. no. 1002 7036

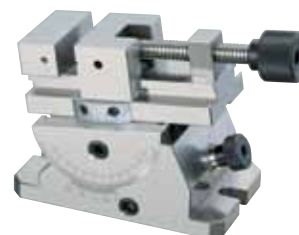

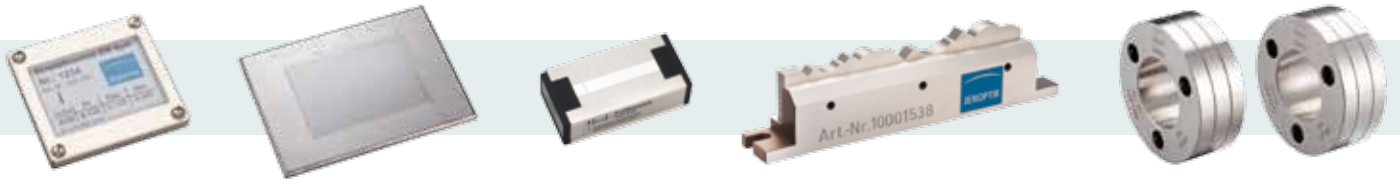

Permanent measuring accuracy

The accuracy can change unnoticed due to constant use and associated wear. The device must therefore be calibrated regularly using measurement calibration standards, as meaningful and accurate results can only be generated if the measuring instruments are calibrated accordingly.

Surface inspection standards

To check surface measuring systems with the profile method:

- **Depth setting standard** in polished glass with grooves of differing depths for determining the vertical amplification and the repeatability
- **Geometry standard** in glass or nickel (hard or extra hard coating) with uniform groove profile for checking the entire measurement system
- **Roughness standard** in steel with irregular surface profile replicated from practice for checking the entire measuring system

KN8 contour standard

Compliant with VDI/VDE Directive 2629.

Measurement features: radii, angles, horizontal and vertical distances

Vertical measuring range: 4.5 mm/7.5 mm

Horizontal measuring range: max. 82 mm

Including holder and DAkks-DKD calibration certificate.

Art. no. 1000 1678

Twist standards

For verification of twist measuring systems.

Calibrated parameters: Dt, DP, DG and Dy.

Including test report.

Art. no. 1001 6265

DAkks-DKD calibration laboratory

At our EN ISO/IEC 17025 accredited, vibration-free and air-conditioned DAkks-DKD calibration laboratory we conduct fundamental and application based research and perform calibration processes on your standards.

This ensures direct tracing of the gaging components to the Federal Physical-Technical Institute (PTB, Physikalisch-Technische Bundesanstalt) and guarantees measurements and calibrations at the highest technical standard for measuring.

If a standard cannot be calibrated, a new one can be obtained directly from any of our manufacturing facilities. Simple factory calibration certificates and test reports for non-accredited parameters are also available. We also carry out capability tests for demanding measurement tasks.

Our range of calibration services

Our DAkks-DKD accreditation includes the measurement of variables such as roughness, profile depth, roundness, straightness, and parallelism as well as contour standards and roughness measurement instruments. Within this scope we offer:

DAkks-DKD calibration certificates

- for roughness standards
- for contour standards
- for form standards
- for cam shaft standards



Manual surface finish measurement right where you need it

Point of Use metrology equipment is tailored for roughness measurements, on a wide variety of workpieces, utilizing application specific designs. These systems deliver safe and repeatable positioning of the measuring devices, at pre-defined measurement locations, even for hard to access areas. As an example, Point of Use bore gages (B30) are designed with an adjustable depth ring that allows positioning of the probe at pre-determined depths.

Measurement in bores



The HOMMEL-ETAMIC B30 measures roughness in bores, using customized I.D. tooling with built in wireless surface testers.

Measurement on plane surfaces



The HOMMEL-ETAMIC T30 is designed to measure roughness on a wide variety of plane surfaces using pre-made templates to accurately position the traverse unit on the workpiece.

Measurement on shafts

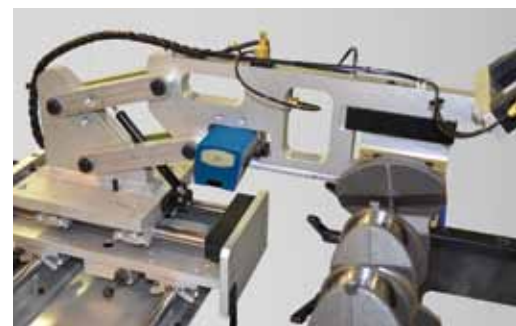

The HOMMEL-ETAMIC S30 is intended for shaft measurement, using unique "scissoring" technology to accurately position the wireless traverse unit.

Highlights HOMMEL-ETAMIC POU

- Secure and accurate positioning of the traverse unit on the workpiece
- Repeatable measurement results due to template positioning
- Unique "scissoring" technology for shaft type workpieces
- Skidded or skidless probing systems
- Included roughness standards for measuring system verification
- Ideal for work pieces such as engine blocks, cylinder heads, valve bodies or housings, as well as crank shafts, cam shafts and connecting rods

Individual, semi-automatic production measuring stations

HOMMEL-ETAMIC waveslide measuring stations are individually tailored to suit specific measurement tasks. They are based on proven T8000 system components and provide reliable, semi-automatic measurements in the manufacturing environment. The measuring systems are extremely robust and operate with high precision. The workpiece is positioned manually via guided air slides and the measuring process is fully automated.



The HOMMEL-ETAMIC waveslide measures roughness on shaft-type or cubic workpieces that are positioned manually via a measuring table with air slides.



Highlights HOMMEL-ETAMIC waveslide

- Simple, manual positioning of the workpiece via air slides
- For medium to large cubic or shaft-type workpieces
- Manual operation
- For roughness and contour measuring tasks

Time-saving measurement in production: fully automated measuring systems

The HOMMEL-ETAMIC wavemove measuring stations allow individual, CNC-controlled, fully automated roughness and contour measurements to be performed directly on the production line. These stations are based on the T8000 platform and are enhanced with CNC axes and workpiece fixtures specific to the part. This enables them to perform complex measuring tasks on cubic or wave-shaped workpieces in a fully automated process.



Highlights HOMMEL-ETAMIC wavemove

- Automated surface measurements for workpiece-specific applications
- High degree of automation
- Robust measuring stations suitable for production
- Transfer of the measurement results to programs such as qs-STAT®
- Flexible system concept for a wide range of applications
- Simple measurement program creation
- Up to eight independent CNC axes operating simultaneously
- Workpiece carrier with automatic identification of the workpiece
- Extensive safety equipment
- Advanced technology for a high degree of reliability



The calibration of the measurement system is automated via integrated roughness and contour standards.



The probe is swiveled by 90° for roughness measurements on pin bearings.

Application example: HOMMEL-ETAMIC wavemove for crank shafts

- Fully automated measurement of roughness and twist on crank shaft bearings
- Optional contour measurement, e.g. of groove radii
- Workpiece held between tips using carrier disk and tailstock
- System check via integrated roughness and contour standards
- Automated axes for::
 - X/Y-axis travel movement of the measuring column
 - Vertical positioning of the traverse unit (Z-axis)
 - Rotary drive for rotation of the crank shaft
 - Motorized tilt unit for the traverse unit
 - Optional: CNC-controlled rotation module for lateral probing or measurement in the overhead position

**Application example:
HOMMEL-ETAMIC wavemove
for cubic workpieces**

- Fully automated measurement of roughness and contour on cylinder heads and blocks
- Workpiece-specific fixing device with optional workpiece carrier detection
- Various fixing devices enable flexible use for different workpieces
- Twist and tilt axis for workpiece positioning
- Extensive safety devices for monitoring the workpiece
- Optional light curtain to protect operating personnel



Surface inspection system for cylinder bores



HOMMEL-ETAMIC toposcan OR150 with mobile workstation

The toposcan is the ideal inspection system for fast, precise, and reliable testing of finely machined (e.g. honed) surfaces of cylinder bores during motor production as well as development and tests.

Optical testing of surface structure characteristics and tactile measurement of surface roughness is carried out using a compact measuring probe.

Highlights HOMMEL-ETAMIC toposcan

- Mobile use thanks to its light weight
- Ergonomic design for comfortable operation
- Easy adaptation to different bore diameters
- High optical zoom, up to 210 times for finest structures
- Automatic determination of crosshatch angle



The toposcan OR150 offers a lighting unit and a roughness probe for determining all relevant surface characteristics. The roughness standard allows for immediate verification of the measuring system. The centering plate is adapted to the diameter of the cylinder bore.



Thanks to the ergonomic design of the control elements, operation of the toposcan system is easy and secure. The mobile workstation simplifies its flexible use in the production environment.

HOMMEL-ETAMIC toposcan at a glance

- All important functions, such as motorized axial positioning, zoom and focus setting as well as lighting regulation, are carried out using the computer
- Basic model for optical testing and advanced model for additional tactile roughness measurement
- Immediate display of the cylinder bore surface on the computer screen
- Manual radial probe positioning
- Complete evaluation of the cylinder surface thanks to optical inspection and roughness measurement at any position
- Mobile workstation for easy transport in the production environment
- For cylinder bores from 60 mm diameter

Model	Diameter*	Measurement height	Scan-/measuring mode	Roughness measurement	Tabletop model	Workstation model
toposcan O150 or O210	60-110 mm	150 or 210 mm	yes	no	yes	yes
toposcan OR150 or OR210	60-110 mm	150 or 210 mm	yes	yes	yes	yes

* Further diameters on demand

Control and evaluation software for toposcan

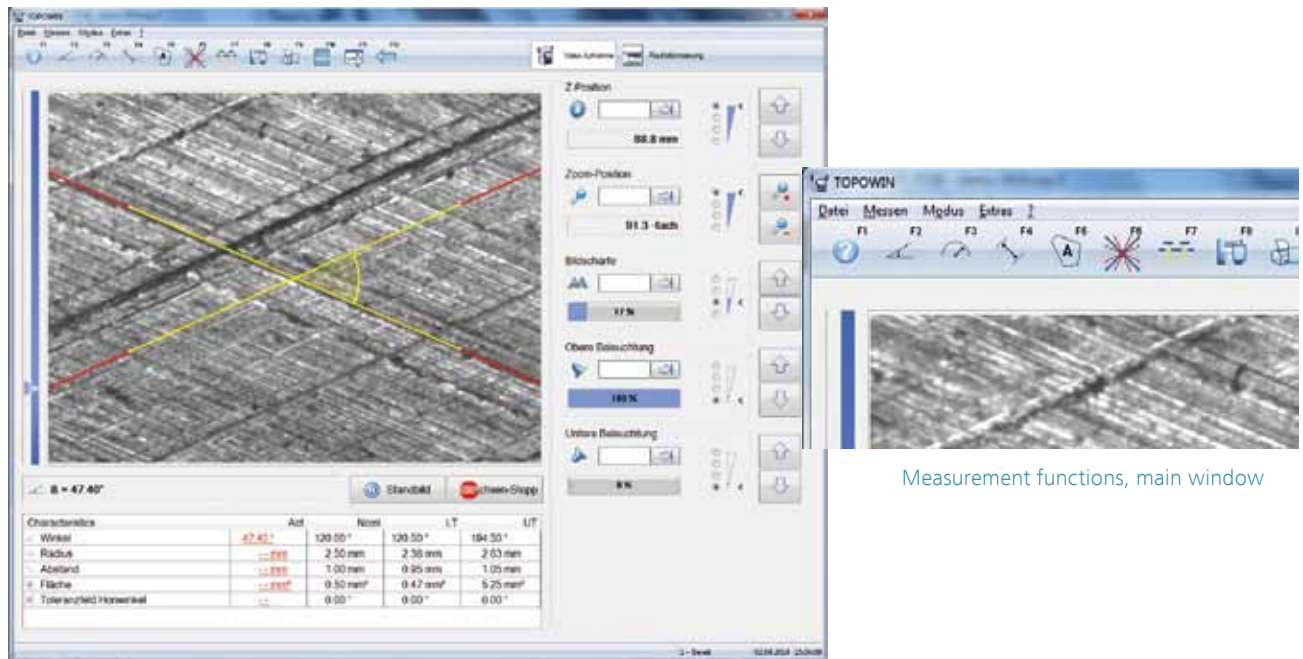



Main window, crosshatch angle

Measurement functions, main window

The user-friendly TOPOWIN software can be operated intuitively and offers a standardized interface for optical surface inspection and roughness measurement.

Highlights HOMMEL-ETAMIC TOPOWIN

- Clear, well-arranged user interface
- Optical inspection with zoom microscope
- High optical zoom, 30 to 210 times
- Imaging of a plateau-honed surface
- Display of finest structures of new surfaces
- High inspection rates and user-independent results thanks to automated measuring runs
- Immediate display of the roughness profile and the results of the preset characteristics
- Local correlation of optical inspection and tactile roughness measurement
- Continuous development of the software in regards to new standards

	Customer Smith Corp.	Test Plan motor14.jpg	
	Measuring System KOHMMQ-ETAMIC topozcan	Workpiece 4-cylinder motor block	
Order Number 123 478 001	Serial Number 88 150 10 201	Operator Johnson	SW version 7.60
		Date 2014/04/02	Time 15:47

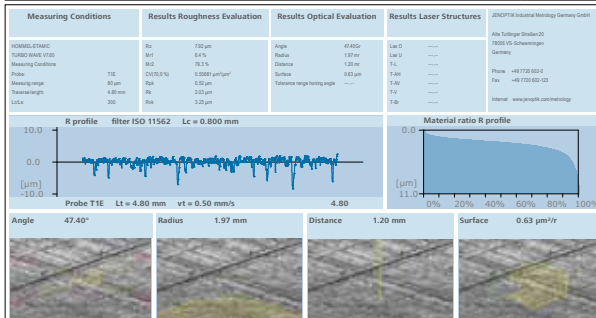

Logging

Simple documentation

The numerical and graphical output of the roughness parameters and the profiles can be combined with the image evaluations in one report to provide compact and informative documentation. Documentation can either be archived as a printout or a PDF file.

qs-STAT® data export interface (optional)

The data export interface supports the Q-DAS ASCII transfer format for the exchange of quality information via Q-DAS software modules. Predefined parameter sets and the possible use of predefined catalogs simplify set-up of the data interface. The interface is certified by Q-DAS according to AQDEF specifications (Automotive Quality Data Exchange Format).

Laser pocket structures: measurement and evaluation of laser-structured surfaces (optional)

In combustion engines, grooves can be cut into the upper reverse area of the piston with a laser to reduce wear rates, which creates a higher oil pressure volume for improved lubrication of the piston rings.

This software module makes it easy to determine the geometric dimensions of the laser pocket structures. A measuring assistant guides the user through the measuring process.

Automatic runs: CNC control (optional)

Automatic positioning at preselected inspection heights, which are then used to automatically carry out a sequence of several cross hatch angles or roughness measurements.

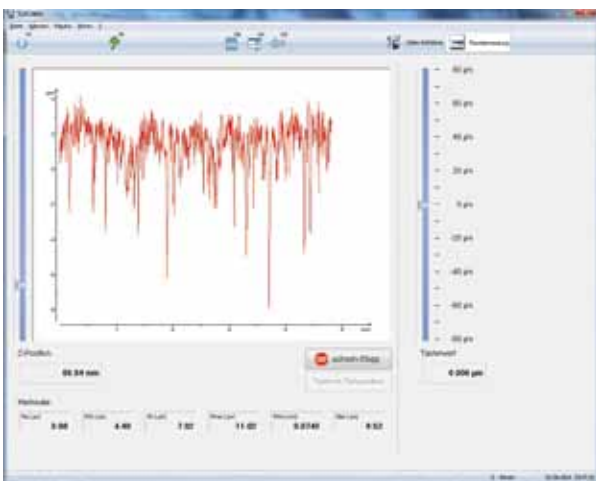

Roughness measurement: immediate profile display

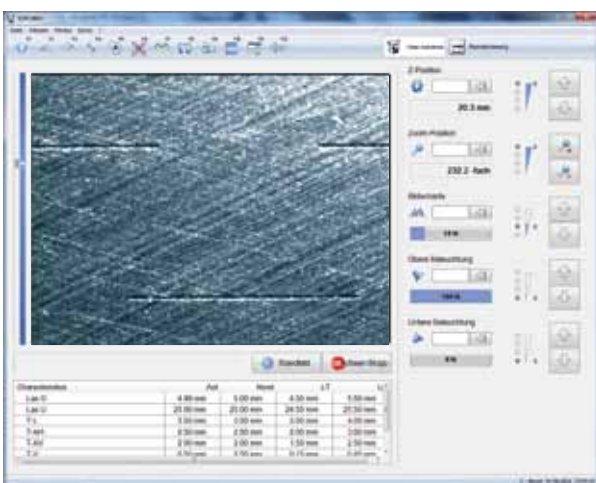

Determination of laser pocket structures

Technical data stationary roughness and/or contour measuring systems (pages 16 – 27)

	Roughness measurement	Contour measurement			
HOMMEL-ETAMIC	T8000 R120-400 / T8000 R120-800	C8000-400 digital / C8000-800 digital	T8000 C120-400 digital / T8000 C200-800 digital	C8000-400 digiscan / C8000-800 digiscan	T8000 C120-400 digiscan / T8000 C200-800 digiscan
Probing system	roughness probe TKU 300/600	wavecontour™ digital	wavecontour™ digital	wavecontour™ digiscan	wavecontour™ digiscan
Measuring range	±300 µm or ±600 ¹⁾ µm	60 mm	60 mm	60 or 90 ⁴⁾ mm	60 or 90 ⁴⁾ mm
Resolution	1 nm or 2 nm ¹⁾	50 nm	50 nm	50 or 75 ⁴⁾ nm	50 or 75 ⁴⁾ nm
Probe arm identification	–	–	–	electronic, RFID	electronic, RFID
Probe force setting	–	0 – 20 mN	0 – 20 mN	electronic	electronic
Top/bottom measurement	–	–	–	optional	optional
Measuring stroke limitation	–	programmable	programmable	programmable	programmable
Probe arm					
Stylus tip	diamond 2 µm/90°	carbide 20 µm	carbide 20 µm	carbide 20 µm	carbide 20 µm
Mounting	exchangeable ⁶⁾	quick fastener	quick fastener	magnetic holder	magnetic holder
Traverse unit					
Measuring range (traverse length)	120 mm	120 mm	120 mm / 200 mm	120 mm	120 mm / 200 mm
Resolution	0.1 µm	0.1 µm	0.1 µm / 0.01 µm	0.1 µm	0.1 µm / 0.01 µm
Measurement speed vt	0.1 – 3 mm/s	0.1 – 3 mm/s	0.1 – 3 mm/s	0.1 – 3 mm/s	0.1 – 3 mm/s
Positioning speed	max. 3 mm/s	max. 3 mm/s	max. 3 mm/s / max. 9 mm/s	max. 3 mm/s	max. 3 mm/s / max. 9 mm/s
Straightness accuracy	≤0.4 µm/120 mm	≤0.4 µm/120 mm	≤0.4 µm/120 mm / ≤0.8 µm/200 mm	≤0.4 µm/120 mm	≤0.4 µm/120 mm / ≤0.8 µm/200 mm
Measuring column					
Vertical travel	400 mm / 800 mm	400 mm / 800 mm	400 mm / 800 mm	400 mm / 800 mm	400 mm / 800 mm
Auto-null function	in Z-, programmable	in Z-, programmable	in Z-, programmable	in Z-, programmable	in Z-, programmable
Positioning repeatability	≤50 µm	≤50 µm	≤50 µm	≤50 µm	≤50 µm
Travel speed	0.1 – 12 mm/s / 0.1 – 50 mm/s	0.1 – 12 mm/s / 0.1 – 50 mm/s	0.1 – 12 mm/s / 0.1 – 50 mm/s	0.1 – 12 mm/s / 0.1 – 50 mm/s	0.1 – 12 mm/s / 0.1 – 50 mm/s
Measuring station					
Granite plate (L x W x H)	780 x 500 x 100 mm / 1000 x 500 x 140 mm	780 x 500 x 100 mm / 1000 x 500 x 140 mm	780 x 500 x 100 mm / 1000 x 500 x 140 mm	780 x 500 x 100 mm / 1000 x 500 x 140 mm	780 x 500 x 100 mm / 1000 x 500 x 140 mm
Damping	optional ²⁾	optional ²⁾	optional ²⁾	optional ²⁾	optional ²⁾
Instrument table (L x W x H)	optional ³⁾	optional ³⁾	optional ³⁾	optional ³⁾	optional ³⁾
Working table (L x W x H)	–	–	–	–	–

Power supply: 100-240 V AC 50/60 Hz; operating temperature: +18° to +25° C, relative humidity max. 85 %, without condensation (Δ T 2° C/h); storage temperature: +10 to 50° C.

- 1) In smallest measuring range
- 2) Optional passive damping or optional active level control
- 3) Optional instrument tables (except nanoscan) (L x W x H): GTR4 2000 x 800 x 700 mm or GTR5 2200 x 800 x 700 mm
- 4) 1.5 fold probe arm length
- 5) 2 fold probe arm length
- 6) Optional: magnetic holder with collision protection

Characteristics roughness measurement with EVOVIS (page 28)

Characteristic	Description
Measuring range/resolution	±8 µm/1 nm; ±16 µm/2 nm; ±80 µm/10 nm; ±400 µm/50 nm
Metric system	µm/µinch selectable
Filter: cut-offs	0.08/0.25/0.8/2.5/8 [mm], selectable in -2 to +1 cut-off steps; variable from 0.001 – 80 in 0.001 steps
EN ISO 11562, part 1	Gauss (M1) digital filter [mm], cut-offs 0.08/0.25/0.8/2.5/8
EN ISO 13565-1	2-fold Gauss (M2) Rk parameters, cut-offs 0.08/0.25/0.8/2.5/8
ISO/TS 16610-31	robust Gauss filter; cut-offs 0.08/0.25/0.8/2.5/8
ISO/TS 11610-21	linear Gauss filter
ISO/TS 16610-22	linear Spline filter
ISO 3274/11562	short-wave cut-off λs, selectable in λc or manually
Measurement speed vt	lt – 0.05/0.15/0.5 mm/s; variable from 0.01 – 2 mm/s in 0.01 steps
Traverse length lt	0.48/1.5/ 4.8/15/48 mm or variable from 0.1 – 120/200 mm (depending on traverse unit)
Evaluation length ln	0.4/1.25/4/12.5/40 mm or variable cut-offs
Cut-off [mm]	0.08/0.25/0.8/2.5/8
Parameters EN ISO 4287:2010	
- Roughness	Rt, Ra, Rz, Rp, Rv, Rq, RSm, Rc, Rsk, Rku, RΔq, Rmr, C(Rmr), Rmr(c), Rdc
- Profile	Pt, Pa, Pz, Pp, Pv, Pq, PSm, Pc, Psk, Pku, PΔq, Pmr, C(Pmr), Pmr(c), Pdc
- Waviness	Wt, Wa, Wz, Wp, Wv, Wq, WSm, Wc, Wsk, Wku, WΔq, Wmr, C(Wmr), Wmr(c), Wdc
Core roughness parameters EN ISO 13565-2	Rpk, Rk, Rvk, Mr1, Mr2, Vo, Rpk*, Rvk*, A1, A2
Motif parameters EN ISO 12085	R, Rx, AR, Nr, W, Wx, AW, Wte, Nw
Roughness parameters JIS B-0601	Rz-JIS
Roughness parameters EN 10049 and SEP 1941	Ra, R _{Pc} W _{sa} , W _{ca}
Roughness parameters obsolete standards ISO 4287:1987, DIN 4762	Rmax, RzISO, D, Δa, Δq, L0
Roughness parameters Daimler standard MBN 31 007	R3z, Rp3z, R3zm
Waviness parameters VDA 2007 (optional)	WDSm, WDt, WDC
Twist parameters Daimler standard MBN 31 007-07 (optional)	DG, Dt, DP, DF, DFu, DLU, Dy

Combined roughness and contour measurement

T8000 RC120-400 digital / T8000 RC120-800 digital	T8000 RC120-400 digiscan / T8000 RC120-800 digiscan	surfscan 120-400 / surfscan 120-800	nanoscan 855
roughness probe TKU 300/600 wavecontour™ digital R: ±300 µm or ±600 µm; C: 60 mm R: 1 nm or 2 nm ¹⁾ ; C: 50 mm – R: –; C: 0 – 20 mN – programmable	roughness probe TKU 300/600; wavecontour™ digiscan R: ±300 µm or ±600 µm; C: 60 or 90 ⁴⁾ mm R: 1 nm or 2 nm ¹⁾ ; C: 50 or 75 ⁴⁾ mm R: –; C: electronic, RFID R: –; C: electronic optional programmable	roughness and contour combined 6 or 12 ⁵⁾ mm 6 or 12 ⁵⁾ mm electronic, RFID electronic optional programmable	roughness and contour combined, opto-mechanical 24 or 48 ⁵⁾ mm 0.6 or 1.2 ⁵⁾ nm electronic, RFID electronic yes programmable
R: 2 µm/90°; C: carbide 20 µm R: exchangeable ⁶⁾ ; C: quick fastener	R: 2 µm/90°; C: carbide 20 µm R: exchangeable ⁶⁾ ; C: magnetic holder	diamond 2 µm/60°; ruby ball ø 1 mm magnetic holder with collision protection	diamond 2 µm/60°; ruby ball ø 1 mm; carbide 20 µm magnetic holder with collision protection
120 mm 0.1 µm 0.1 – 3 mm/s max. 3 mm/s ≤0.4 µm/120 mm	120 mm 0.1 µm 0.1 – 3 mm/s max. 3 mm/s ≤0.4 µm/120 mm	120 mm 0.1 – 10 µm 0.1 – 3 mm/s max. 3 mm/s ≤0.4 µm/120 mm	200 mm 0.01 µm 0.1 – 3 mm/s max. 9 mm/s ≤0.4 µm/200 mm
400 mm / 800 mm in Z-, programmable ≤50 µm 0.1 – 12 mm/s / 0.1 – 50 mm/s	400 mm / 800 mm in Z-, programmable ≤50 µm 0.1 – 12 mm/s / 0.1 – 50 mm/s	400 mm / 800 mm in Z-, programmable ≤10 µm 0.1 – 12 mm/s / 0.1 – 50 mm/s	550 mm in Z+/Z-, programmable ≤10 µm 0.1 – 50 mm/s
780 x 500 x 100 mm / 1000 x 500 x 140 mm optional ²⁾ optional ³⁾ –	780 x 500 x 100 mm / 1000 x 500 x 140 mm optional ²⁾ optional ³⁾ –	780 x 500 x 100 mm / 1000 x 500 x 140 mm optional ²⁾ optional ³⁾ –	850 x 600 x 140 mm active level control with damping function 1190 x 800 x 780 mm 810 x 800 x 780mm

Technical data surface inspection systems (pages 48 – 49)

HOMMEL-ETAMIC	toposcan O150 / O210	toposcan OR150 / OR210
Diameter*	60 – 110 mm	60 – 110 mm
Axial measurement height	150 / 210 mm	150 / 210 mm
Optical zoom	30 – 210 times (on the screen)	30 – 210 times (on the screen)
Test zone (approx.)	40 times: 5.1 x 3.8 mm; 100 times: 2.0 x 1.5 mm; 210 times: 0.9 x 0.7 mm	40 times: 5.1 x 3.8 mm; 100 times: 2.0 x 1.5 mm; 210 times: 0.9 x 0.7 mm
Resolution CCD camera	1360 (H) x 1024 (V)	1360 (H) x 1024 (V)
Presentation on the screen	752 (H) x 582 (V)	752 (H) x 582 (V)
Illumination	18 LEDs individually switchable; 2 channel dimmable	18 LEDs individually switchable; 2 channel dimmable
Axial position	motor-driven	motor-driven
Radial position	manual	manual
Focus adjustment	motor-driven	motor-driven
Operating modes	optical surface inspection –	optical surface inspection tactile roughness measurement
Optical evaluation	hone angle; stroke reversal radius; spaces/width of grooves; detection of blow holes and pores; tolerance zone (angle); laser structure (optional)	hone angle; stroke reversal radius; spaces/width of grooves; detection of blow holes and pores; tolerance zone (angle); laser structure (optional)
Roughness evaluation Parameters EN ISO 4287 Parameters EN ISO 13565-1, -2 Parameters Motif EN ISO 12085 ASME B46 JIS B601 EN 10049 Daimler MBN 31007	– – – – – – –	Ra, Rz, Rmax, Rt, Rq, RSm, Rmr(c)[%], Rmr(c)[µm], Rp Rk, Rpk, Rvk, Mr1, Mr2, A1, A2 R, AR, Rx Rpm Rz-JIS RPC R3z
Probe	–	inductive skid probe T1E 5 µm/90°
Traverse length according to ISO/JIS	–	1.5/4.8/15 mm
Cut-off (ISO/JIS)	–	0.25/0.8/2.5 mm
Measurement speed vt	–	0.15/0.5/1 mm/s; return speed 3 mm/s
Logging	axial height of view; set magnification; date/time; parts identification	axial height of view; set magnification; date/time; parts identification
Dimensions (L x W x H), weight Inspection system Workstation	110 x 90 x 640 mm, 5.2 kg** / 110 x 90 x 760 mm, 5.4 kg** 650 x 800 x 1180, 70 kg (with PC)	110 x 90 x 640 mm, 5.5 kg** / 110 x 90 x 760 mm, 5.7 kg** 650 x 800 x 1180, 70 kg (with PC)

Power supply 100-240 V AC 50/60 Hz; power consumption 200 W; operating temperature +5° to +40° C without condensation.

* Further diameters on demand

** Including 80 mm centering plate

Technical data mobile roughness measuring systems (pages 6 – 11)

HOMMEL-ETAMIC	W5	W10	W20
Measuring principle	profile method, calibrated	profile method, calibrated	profile method, calibrated
Total deviation as per DIN 4772	class 1	class 1	class 1
Traverse unit Suitable probes Tracing length Probing direction Probing range Control elements	integrated into basic unit skid probe 17 mm axial over 360° integrated start button	LV17 skid probe 17 mm axial, transverse probing over 360° integrated start button	waveline™ 20 skidless probe 20 mm axial over 360° integrated start button, inclination reference level
Probe (standard)	T1E, 2 µm/90°	T1E, 2 µm/90°	TKL 300L, 2 µm/90°
Measuring range/resolution	±100 µm/6 nm*	±100 µm/6 nm*	±300 µm/12 nm*
Traverse length lt according to ISO/JIS according to Motif max.	1.5/4.8/15 mm 0.64/3.2/16 mm 17.5 mm	1.5/4.8/15 mm 0.64/3.2/16 mm 17.5 mm	1.5/4.8/15 mm 0.64/3.2/16 mm 20 mm
Cut-off according to EN ISO 4288/JIS B601	0.25/0.8/2.5 mm	0.08/0.25/0.8/2.5/8 mm	0.08/0.25/0.8/2.5/8 mm
Sampling length lr	1 to 5 selectable	1 to n (max. traverse length)	1 to n (max. traverse length)
Filter	EN ISO 11562: Gauss filter EN ISO 16610-21: Gauss filter EN ISO 13565-1: filter for Rk parameters EN ISO 3274: As filter	EN ISO 11562: Gauss filter EN ISO 16610-21: Gauss filter EN ISO 13565-1: filter for Rk parameters EN ISO 3274: As filter	EN ISO 11562: Gauss filter EN ISO 16610-21: Gauss filter EN ISO 13565-1: filter for Rk parameters EN ISO 3274: As filter
Measurement speed vt	0.15/0.5/1 mm/s; return speed 3 mm/s	0.15/0.5/1 mm/s; return speed 3 mm/s	0.15/0.5/1 mm/s; return speed 3 mm/s
Display	2" TFT color display	4,3" TFT color display with touchscreen function	4,3" TFT color display with touchscreen function
Roughness and profile parameters EN ISO 4287	23 parameters Ra, Rz, Rmax, Rt, Rq, RSm, Rmr(c)[%], Rmr(c)[µm], Rp	40 parameters Ra, Rz, Rmax, Rt, Rq, RSm, Rc, Rp, Rv, Rsk, Rku, Rdc, Rdq, RzISO, Rmr, Rmr(c), C(Rmr)	68 parameters Ra, Rz, Rmax, Rt, Rq, RSm, Rc, Rp, Rv, Rsk, Rku, Rdc, Rdq, RzISO, Rmr, Rmr(c), C(Rm), Pt, Pz, Pa, Pc, Pp, Pv, PSm, Pq, PSk, Pku, Pdq, Pdc, Pmr, Pmr(c), C(Pmr)
EN ISO 13565-1, -2 Motif EN ISO 12085 ASME B46.1 JIS B601 (2001) EN 10049 Daimler MBN 31007 Specific parameters	Rk, Rpk, Rvk, Mr1, Mr2, A1, A2 R, AR, Rx Rpm Rz-JIS RPe R3z –	Rk, Rpk, Rvk, Mr1, Mr2, A1, A2, Rpk*, Rvk*, Vo0.001 R, AR, Rx, CR, CF, CL, Nr Rp, Rpm Rz-JIS RPe R3z Sealing parameter Rmr (factor*parameter)	Rk, Rpk, Rvk, Mr1, Mr2, A1, A2, Rpk*, Rvk* R, AR, Rx, CR, CF, CL, Nr Rp, Rpm Rz-JIS RPe R3z Sealing parameter Rmr (factor*parameter)
Waviness parameters EN ISO 4287 Motif EN ISO 12085	–	–	Wt, Wz, Wa, Wp, Wv, WSm, Wq, WSk, Wku, Wdq, Wc W, Wx, Aw
Battery (basic unit)	Lithium-ion battery, up to 800 measuring cycles (no printout, lt 4.8 mm), full charge approx. 4 h	Lithium-ion battery, up to 800 measuring cycles (no printout, lt 4.8 mm), full charge approx. 4 h	Lithium-ion battery, up to 800 measuring cycles (no printout, lt 4.8 mm), full charge approx. 6 h
Measuring programs	5	7 plus 1 for system verification	7 plus 1 for system verification
Data memory (per measuring program)	max. 2000 measuring data records/parameters and 500 profile data records	max. 2000 measuring data records/parameters and 500 profile data records	max. 2000 measuring data records/parameters and 500 profile data records
Interfaces	USB, Bluetooth® wireless technology	USB, Bluetooth® wireless technology	USB
Dimensions (L x W x H), weight Basic unit Traverse unit	approx. 50 x 63 x 128 mm, 270 g integrated into basic unit	227 x 225 x 70 mm, 980 g LV17: 151 x 50 x 55 mm, 275 g	227 x 225 x 70 mm, 1080 g waveline™ 20: 245 x 54 x 75 mm, 1100 g
Printer Printing method Paper/printing width Paper roll Resolution Printing functions	optional printer P5 static thermal print lines 57 ±0.5 mm/48 mm Ø = 31 mm 8 points/mm, 384 points/line measuring conditions, parameters, roughness profile, Abbott curve	integrated static thermal print lines 57 ±0.5 mm/48 mm Ø = 31 mm 8 points/mm, 384 points/line measuring conditions, parameters, roughness profile, Abbott curve, statistics	integrated static thermal print lines 57 ±0.5 mm/48 mm Ø = 31 mm 8 points/mm, 384 points/line measuring conditions, parameters, roughness profile, Abbott curve, statistics
Battery Interfaces	battery pack, 1500 mAh Bluetooth® wireless technology	via basic unit via basic unit	via basic unit via basic unit

Power supply: 100-240 V AC 50/60 Hz; operating temperature: +5° C to +40° C; relative humidity max. 85 %, without condensation (Δ T 2° C/h); storage temperature: -20° C to +50° C.
 * Depending on probe used

Description surface standards (page 43)

Standard	Ra	Rz	Rmax	Art.no.	With DAKKS-DKD calibration	Type EN ISO 5436-1	Comments
Geometry standard nickel Geometry standard hard RNDH1 Geometry standard hard RNDH2 Geometry standard hard RNDH3 Geometry standard hard RNDH3 for W10/W20 Geometry standard extra hard RNDX1 Geometry standard extra hard RNDX2 Geometry standard extra hard RNDX3	approx. 0.5 µm approx. 1 µm approx. 3 µm approx. 3 µm approx. 0.5 µm approx. 1 µm approx. 3 µm	approx. 1.6 µm approx. 3 µm approx. 10 µm approx. 10 µm approx. 1.6 µm approx. 3 µm approx. 10 µm	approx. 1.6 µm approx. 3 µm approx. 10 µm approx. 10 µm approx. 1.6 µm approx. 3 µm approx. 10 µm	256 314 231 498 230 292 1006 6899 256 318 256 125 233 213	1000 7576 233 234 233 232 – 1000 7589 256 143 233 233	type C type C type C type C type C type C type C	RSm 0.1 mm RSm 0.1 mm RSm 0.1 mm RSm 0.1 mm RSm 0.1 mm RSm 0.1 mm RSm 0.1 mm
Geometry standard glass Geometry standard GN DIN I Geometry standard GN DIN II	approx. 0.3 µm approx. 0.7 µm	approx. 1.1 µm approx. 2.5 µm	approx. 1.15 µm approx. 2.6 µm	230 744 226 251	230 832 224 935	type C type C	RSm approx. 0.08 mm RSm approx. 0.12 mm
Roughness standards Roughness standard step 1 Roughness standard step 2 Roughness standard step 3 Set of roughness standards (steps 1 – 3) Roughness standard super fine step 2 Roughness standard super fine step 3 Roughness standard ISO 10049, step 2 Roughness standard ISO 10049, step 3	approx. 0.2 µm approx. 0.5 µm approx. 1.5 µm approx. 0.2/0.5/1.5 µm approx. 0.05 µm approx. 0.08 µm approx. 1.25 µm approx. 1.9 µm	approx. 1.5 µm approx. 3 µm approx. 8.54 µm approx. 1.5/3/8.5 µm approx. 0.3 µm approx. 0.45 µm approx. 6.1 µm approx. 9 µm	approx. 2 µm approx. 4 µm approx. 9.5 µm approx. 2/4/9.5 µm approx. 0.4 µm approx. 0.6 µm – –	– – – – – – – –	1000 7524 1000 7525 1000 7526 1000 7527 1007 1807 1007 1808 10000 7486 1000 7453	type D type D type D type D type D type D type D type D	Rpk, Rk, Rvk, Mr1, Mr2 Rpk, Rk, Rvk, Mr1, Mr2 Rpk, Rk, Rvk, Mr1, Mr2 Rpk, Rk, Rvk, Mr1, Mr2 Rpk, Rk, Rvk, Mr1, Mr2 Rpk, Rk, Rvk, Mr1, Mr2 Rpk, Rk, Rvk, Mr1, Mr2 RPe approx. 64 1/cm RPe approx. 64 1/cm
Depth setting standard Setting standard 3 grooves Depth setting standard EN9 (groove approx. 9 µm)	–	–	–	– 226 252	1000 7540 224 937	type A type A	Pt approx. 1/4/9 µm Pt approx. 9 µm

Excellent industrial metrology

WAVELINE

Roughness and Contour Metrology

Mobile, manual and automated measuring instruments for determining roughness, contour, topography and twist; combined systems for roughness and contour measurements; optical surface inspection for cylinder bores and customized solutions.

FORMLINE

Form Metrology

Manual and CNG-controlled systems for measuring form, position and twist, combined form and roughness instrumentation, form measurement systems for cylinder bores, spindle measuring machines, crank shaft and cam shaft measuring machines and work-piece-specific solutions.

OPTICLINE

Optical Shaft Metrology

Optical measuring systems for determining dimensions, form, position and geometric elements on concentric workpieces. Can be used offline, or as an automated SPC measuring station within the production chain and as a customized solution for work-piece-specific requirements.

GAGELINE

Dimensional Metrology

Pre-process, in-process and post-process measuring systems for measuring dimensions via tactile, pneumatic or optical technologies, including manual, semi and fully automatic systems, final inspection machines and individual in-line systems, plus systems for optical surface inspection.

MOVOLINE

In-Process Metrology

Digital measuring heads, control devices and accessories for tactile in-process measurements of diameter, position and length in machine tools, all aimed at controlling the machining process of machine tools.

SERVICELINE

Services Worldwide

Metrological services including training, application studies and start-up support, relocation services, production monitoring, (remote) services and calibration, repairs and spare parts/replacement service, measuring program generation and measurement process optimization.



Head Office
JENOPTIK Industrial Metrology Germany GmbH

Alte Tuttlinger Straße 20
78056 VS-Schwenningen
Germany
Phone +49 7720 602-0

Close to you. Group companies in:

Germany	USA	China
France	Mexico	Singapore
Switzerland	Brazil	South Korea
Spain		India
Czech Republic		

Affiliates and representation worldwide:
www.jenoptik.com/metrology

Please contact us:
info.im@jenoptik.com